

# CRANBORNE AUDIO

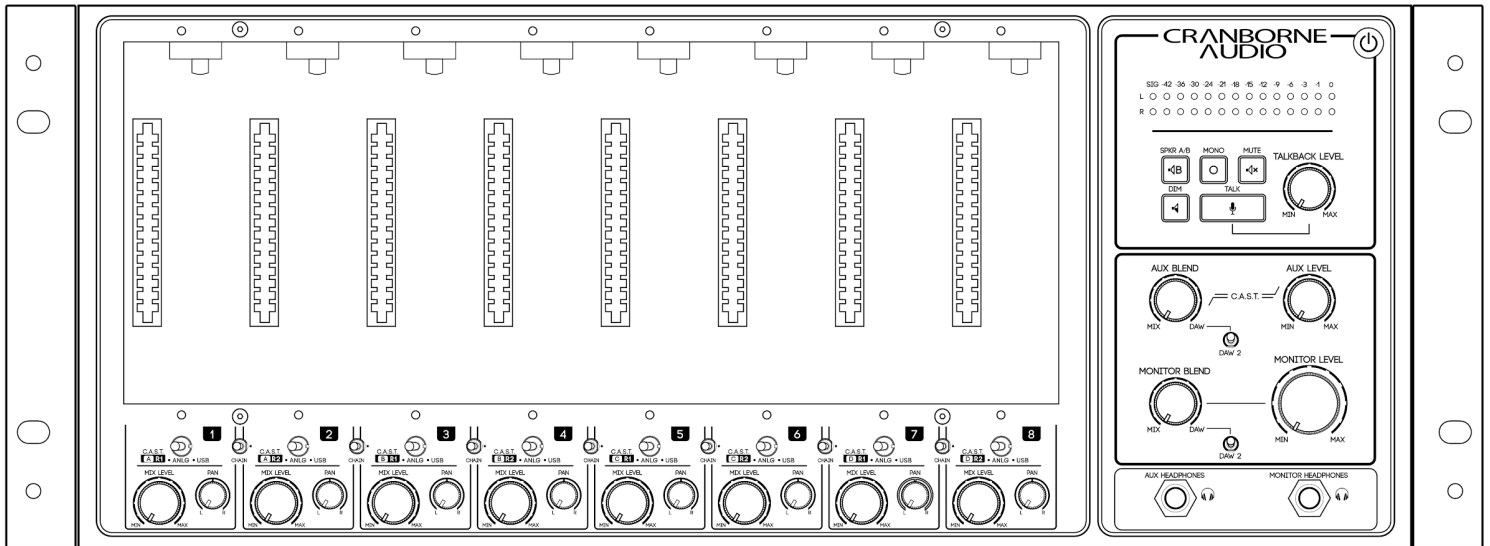

## 500R8 - Analogue/Digital Hybrid USB Audio Interface, Summing Mixer, and 500 Series Rack User Manual

# Welcome to our family

Cranborne Audio represents a commitment by four product designers to build an audio brand that does things the right way. We don't take shortcuts. We don't compromise. We don't accept "good enough."

We're just like you. We're musicians. We're audio engineers.

We make products that we want to use. We create, innovate, and design with passion, purpose, and belief. We strive to design products that remain accessible whilst offering the highest quality and truly innovative new ways of working and achieving that sound that we all desire.

Cranborne Audio, for us, means so much more than metal boxes with components in them. These are our labours of love that embody and demonstrate our demand for excellence. By distilling what matters and putting our soul into these tools, we hope to help other people make magic and express themselves, and in some way, become part of our Cranborne Audio family.

So welcome to our family. We care for our family. And we care about making your tracks, albums, scores sound as good as they should.

# 500R8 User Manual

<b>Getting Started</b>	<b>6</b>
<b>Controls, Switches, and Connectors</b>	<b>6</b>
<b>Package Contents</b>	<b>8</b>
<b>Rack-Ear Orientations</b>	<b>9</b>
Default Shipping Configuration	9
Recessed Configuration	10
Handle Configuration	10
<b>Power Supply</b>	<b>11</b>
Connecting Power	11
Disconnecting Power	11
<b>Powering Procedures</b>	<b>12</b>
Powering On	12
Powering Off	12
<b>Installing and Removing 500 Series Modules</b>	<b>12</b>
Installing Modules	12
Removing Modules	12
<b>Hardware Setup</b>	<b>13</b>
<b>Software Setup</b>	<b>14</b>
Windows Configuration	14
Sample Rate Selection In Windows	14
MacOS X Configuration	15
Sample Rate Selection in MacOS	15
Configuring 500R8 in Your DAW	15
<b>Feature Overview</b>	<b>16</b>
<b>500 Series Rack</b>	<b>16</b>
Module Inputs	16
Inserts	16
Module Direct Outputs	17
Slot Bypass Switch	17
Source Switch	18
Chain Switch	19
<b>500 Series Signal Flow</b>	<b>19</b>
<b>Summing Mixer</b>	<b>20</b>
Mix Level & Pan	20
Summing Mixer Outputs	20
Summing Mixer Expansion Via C.A.S.T. LINK	21
<b>Artist Monitoring Section</b>	<b>22</b>
Aux/Monitor Blend	22
DAW Select Switch	22
DAW 2 Input Jacks	23
Aux/Monitor Level	23

Aux Outputs	23
<b>Monitor Controller</b>	<b>24</b>
Meter	24
SPKR A/B Key	24
Mono Key	25
Mute Key	25
Dim Key	25
Monitor Headphones Output	25
<b>Talkback</b>	<b>26</b>
Talkback Input	26
Talkback Level	26
Talk Key	26
<b>USB Audio Interface</b>	<b>27</b>
USB Inputs	27
USB Outputs	27
USB Channels At Higher Sample Rates	28
High Sample Rates On macOS	28
<b>ADAT</b>	<b>28</b>
ADAT Channels At Higher Sample Rates*	29
<b>S/PDIF</b>	<b>29</b>
<b>Low-Jitter Internal Clock</b>	<b>30</b>
Word Clock Input	30
Word Clock Output	30
Clock Source	31
Configuring Clock Source on Windows	31
Configuring Clock Source on macOS	31
Clock Settings DIP switch	32
<b>MIDI I/O</b>	<b>32</b>
<b>C.A.S.T.</b>	<b>33</b>
C.A.S.T. IN A,B,C & D (RRTT)	33
C.A.S.T. Requirements	34
<b>Cranborne Audio USB Control Panel</b>	<b>35</b>
Windows	35
macOS	36
<b>Application Guides</b>	<b>37</b>
<b>Using 500R8 without 500 series modules</b>	<b>37</b>
<b>Sending Audio From Your DAW, into the 500 Series modules on 500R8</b>	<b>38</b>
<b>Using 500R8 With Hardware Inserts In your DAW</b>	<b>39</b>
Hardware Inserts In Pro Tools	39
Configuring Studio Monitors With 500R8	41
<b>Creating Monitor Mixes For Musicians</b>	<b>42</b>
Creating A Mix	42
Using the DAW 2 Input	43
<b>Adding Reverb Into The Monitor Mix</b>	<b>43</b>

<b>Expanding Your Recording System Using ADAT</b>	<b>44</b>
Using 500R8 and 500ADAT Together	45
C.A.S.T. LINK	46
<b>Using 500R8 In Combination With Your Own AD/DA Converters</b>	<b>47</b>
<b>Understanding C.A.S.T.</b>	<b>48</b>
N22	48
N22H	48
Using N22 and N22H with 500R8	49
<b>Custom Configuration For Logic Pro X Users</b>	<b>50</b>
<b>USB Channel Labelling And Assignments</b>	<b>51</b>
44.1 - 48kHz	51
88.2 - 96kHz	52
176.4 - 192kHz	52
<b>Technical Specifications</b>	<b>53</b>
Digital Performance	53
Analogue Performance	54
System Performance	55
Power	55
Environmental	56
Dims/Weights	56
<b>Troubleshooting</b>	<b>57</b>
<b>Important Safety Instructions</b>	<b>58</b>
General Safety	58
Installation notes	58
Power Safety	59
CE Certification	59
FCC Certification	59
RoHS Notice	60
Instructions for disposal of WEEE by end users in the European Union	60
Electromagnetic Compatibility	60

# Getting Started

## Controls, Switches, and Connectors

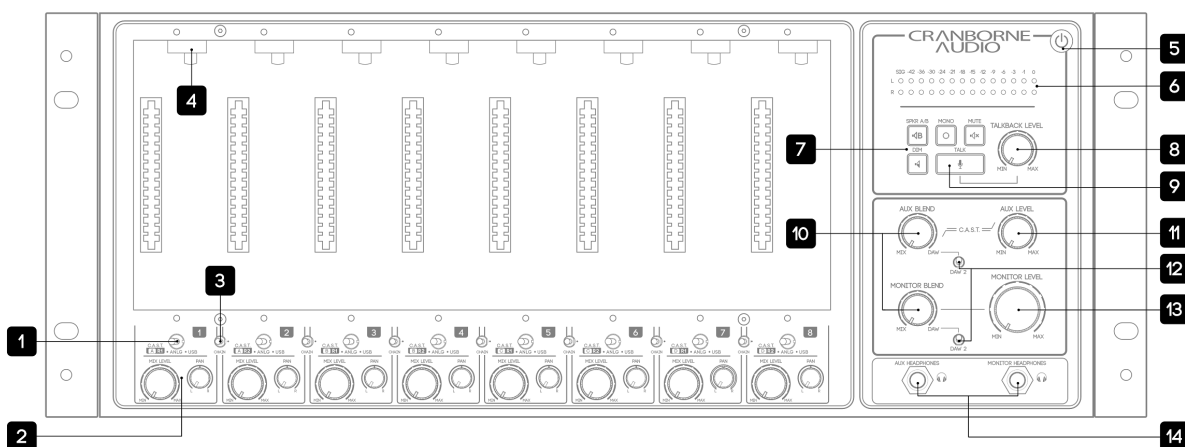

<p><b>[1] Source Switch:</b> Toggles the input source of each 500 series slot between C.A.S.T., Analogue, and USB sources.</p>	<p><b>[8] Talkback Level Control:</b> Adjusts the global level of the Talkback Bus into all destinations.</p>
<p><b>[2] Mix Level &amp; Pan Controls:</b> Adjusts the level and pan position of each 500 series slot into the built-in Summing Mixer.</p>	<p><b>[9] Talk Key:</b> Engages the Talkback facility. Quick press for latching operation, press and hold for momentary operation.</p>
<p><b>[3] Chain Switch:</b> Sends the output of the preceding module into the input of the next. (1 into 2, 2 into 3, 3 into 4 etc).</p>	<p><b>[10] Aux &amp; Monitor Blend Controls:</b> Blends the Summing Mixer and DAW playback together into the Aux and Monitor Busses independently.</p>
<p><b>[4] Slot Bypass Switch:</b> Bypasses the 500 series slot to enable recording without a module installed. All other features function normally when slot bypass is engaged.</p>	<p><b>[11] Aux Level Control:</b> Adjusts the main level of the Aux bus to the Aux Headphones and Aux Output 1/4" jack outputs on the rear panel.</p>
<p><b>[5] Power Switch:</b> Safely powers on and off 500R8 as well as any inserted 500 series module. Tap to power on, press and hold to power off.</p>	<p><b>[12] DAW Select Switches:</b> Assigns an alternate pair of DAW playback returns into the Blend controls for Aux and Monitor busses. DAW 2 is accessed using USB outputs 29/30* or DAW 2 1/4" Jack inputs on the rear panel.</p>
<p><b>[6] Level Meter:</b> Displays the signal level of the Monitor Bus. Meter is positioned pre Monitor Level control in the signal path. The meter scale is in dBFS where 0dBFS = +24dBu.</p>	<p><b>[13] Monitor Level Control:</b> Adjusts the main level of the Monitor Bus to both Monitor Headphones and Speaker Outputs.</p>
<p><b>[7] Monitor Controller Keys:</b> Controls various options for the connected studio monitors including Speaker A/B, Mono, Mute, and Dim functions.</p>	<p><b>[14] Aux &amp; Monitor Headphones Outputs*:</b> Used for connecting Independent headphones to the Aux and Monitor busses.</p>

**Note:**

**\*Only connect headphones to 500R8's headphones outputs. Unbalanced and/or line connections could short leg to ground and cause a spike in power consumption. Any damage caused to the unit as a result of unsupported connections is not covered under the Cranborne Audio warranty.**

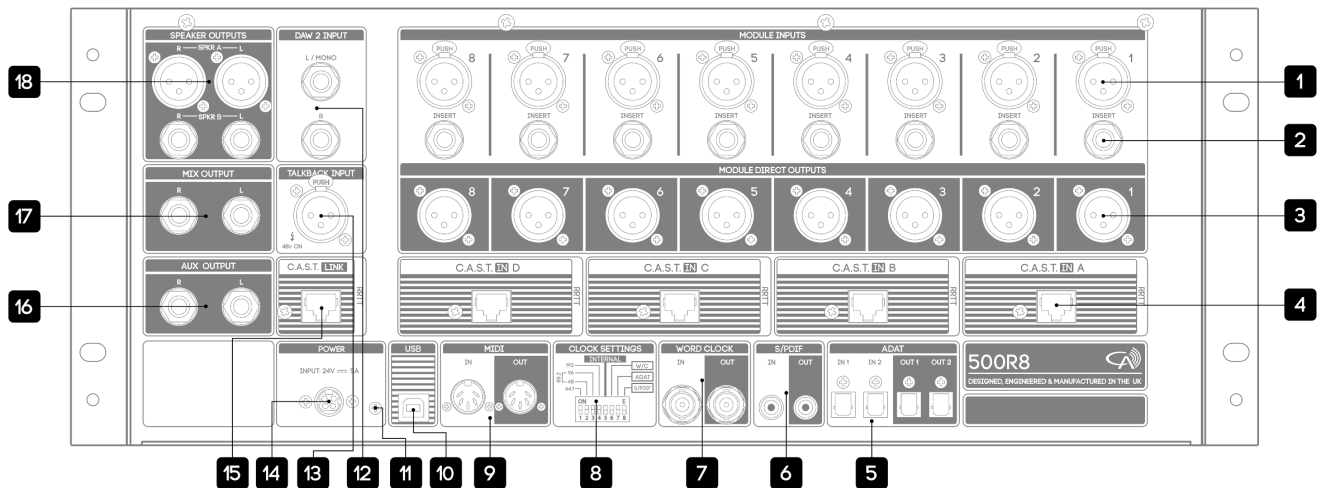

<p><b>[1] Module Input:</b> Connects balanced XLR analogue inputs into each 500 series slot. Input sensitivity varies depending on the type of module inserted.</p>	<p><b>[10] USB 2.0:</b> Connects to a PC, macOS, or Linux device to enable 28-in/30-out USB recording and playback. This connection is compatible with USB 3.0 ports.</p>
<p><b>[2] Insert:</b> Connects external equipment in-line after the 500 series module but before the A/D of each 500 series slot. Utilises a standard Y-split or insert cable. (Tip=send, Ring=return).</p>	<p><b>[11] Grounding Post:</b> Enables direct binding to chassis ground to help eliminate ground loops in specific setups.</p>
<p><b>[3] Module Direct Outputs:</b> Sends balanced, line-level outputs of each 500 series slot for connection to external converters and equipment. Module Direct Outputs are positioned post-insert point, pre Mix Level.</p>	<p><b>[12] DAW 2 Input:</b> Connects analogue playback sources from external audio interfaces directly into 500R8's monitoring paths. Inputs are summed with the DAW 2 USB outputs.</p>
<p><b>[4] C.A.S.T. A, B, C, &amp; D Inputs:</b> Enables I/O relocation and expansion via Cranborne Audio C.A.S.T. enabled breakout boxes.</p>	<p><b>[13] Talkback Input:</b> Connects external microphones directly into 500R8's Talkback facility. Phantom power is always ON. Dynamic or Condenser mics can be used.</p>
<p><b>[5] ADAT I/O:</b> Interfaces 16-in/16-out ADAT optical lightpipe channels directly into 500R8's USB interface.</p>	<p><b>[14] Power:</b> Provides 500R8 with power via the provided external 24v 5A DC power supply. No other power supply should be used.</p>
<p><b>[6] S/PDIF I/O:</b> Interfaces 2-in/2-out S/PDIF and AES3 directly into 500R8's USB interface. S/PDIF I/O operates at 44.1kHz &amp; 48kHz sample rates.</p>	<p><b>[15] C.A.S.T. link:</b> Enables linking of Summing Mixers between 500R8 and 500ADAT. C.A.S.T. link transmits the Aux Mix (inc Talkback) into the connected 500ADAT for monitoring.</p>
<p><b>[7] Word Clock I/O:</b> Enables sending and/or receiving word clock information to/from external digital devices.</p>	<p><b>[16] Aux Output:</b> Connects balanced line outputs of 500R8's Aux Bus to external monitoring devices or similar via 1/4" jacks.</p>
<p><b>[8] Clock Settings DIP switch:</b> Not utilised – Sample rate &amp; clock settings controlled by 500R8 software panel/DAW.</p>	<p><b>[17] Mix Output:</b> Connects line outputs of 500R8's built-in Summing Mixer directly to external converters or similar via 1/4" jacks.</p>
<p><b>[9] MIDI I/O:</b> Converts MIDI information to USB for sending/receiving note and program information.</p>	<p><b>[18] Speaker A/B Outputs:</b> Connects two discrete sets of speakers to 500R8's Monitor Controller for main and reference monitoring via XLR and 1/4" Jack.</p>

## Package Contents

So now your 500R8 is out of its packaging, you're probably itching to get it powered on and making music! But before you get started, please read the sections below that will help guide you through the process of getting 500R8 setup, plugged in, and ready-to-record as quickly as possible!

The following items can be found in the packaging alongside 500R8:

- External power adapter
- IEC cable
- 16 module fixing screws (crosshead, 4-40 thread size)
- Allen key (2.5mm)
- Quickstart Guide

**Note:**

***To reduce environmental waste, 500R8 does not ship with a USB cable to connect it to a host device for recording/playback. To use 500R8 as a USB audio interface, you will need to source a USB Type A or Type C to Type B cable - which are common cables for peripheral USB devices.***



## Rack-Ear Orientations

There's more to 500R8's rack ears than meets the eye. The default shipping configuration features the rack ears mounted flush to the front panel of 500R8 - the most common method for rack-mounting.

500R8 can also be set backwards into its rack ears to allow the front panel controls to sit behind the front of the rack for protection during travelling and location recording.

Finally, both of 500R8's rack ears can be removed, placed back-to-back, and attached to 500R8 as a convenient carry-handle for travelling.

Depending on your desired use case, you may need to reorientate the rack ears and position the rubber feet to best suit your application by using the supplied 2.5mm allen key.

### Default Shipping Configuration

Standard rack-ear configuration used for rack-mounting 500R8 into standard 19" rack. If you would like to secure 500R8 into a 19" rack, the rubber feet should be removed from the unit using the allen key provided.

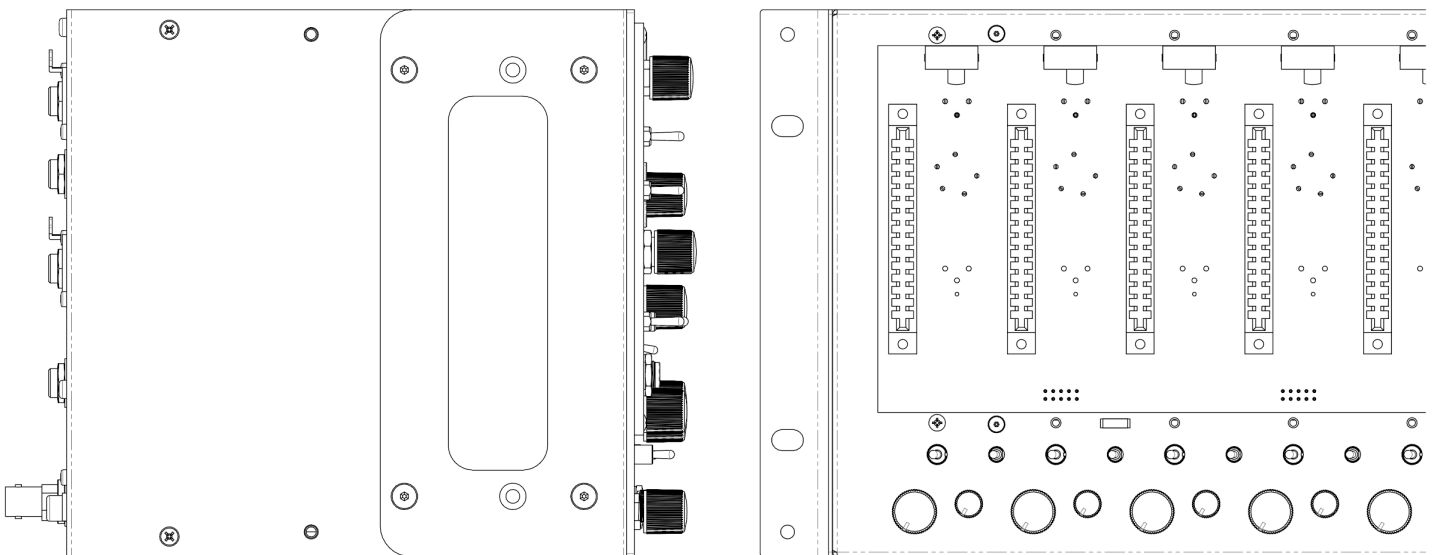

**Note:**

***Whilst 500R8 features plenty of ventilation to ensure that it remains cool during operation, some 500 series modules (and valve-based modules in particular) can run extremely hot and will cause 500R8 to heat up quickly. When rack mounting 500R8, please leave a 1u space above and below the unit to ensure that the ventilation is clear and fully-effective.***

## Recessed Configuration

Recesses 500R8 into a 19" rack to protect all of its front panel controls during transportation. To position the rack ears in this configuration, remove both rack-ears and slide them forward until the holes align with a second set of thread posts on 500R8. Once aligned, secure the rack-ears with the 8x rack ear screws using the allen key provided.

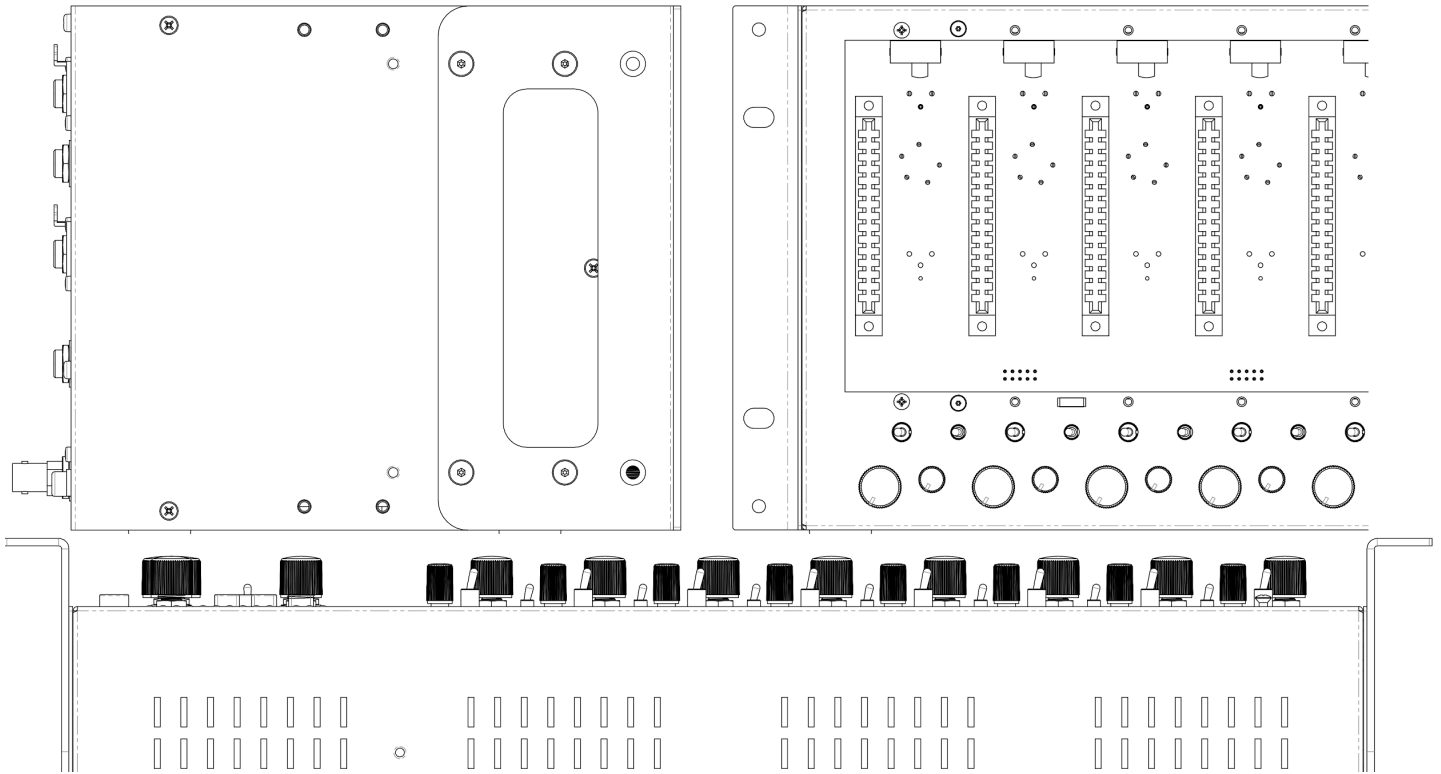

## Handle Configuration

Creates a convenient carry-handle for short-distance transportation. To position the rack ears in this configuration, remove both of the rack ears and reposition them back-to-back onto the *left* side of 500R8. Secure them into place using 4x rack ear screws and the allen key provided. Store the leftover rack-ear screws in a safe place for future use.

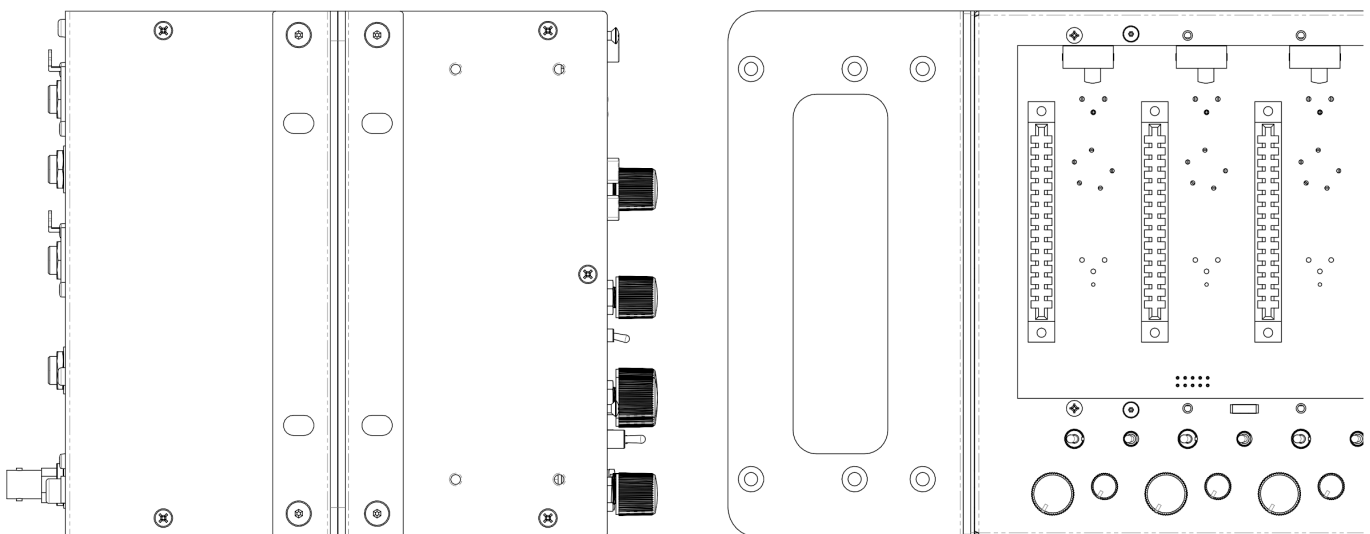

## Power Supply

500R8 is powered via an external 24v 5A DC switch-mode power supply that supports any operating voltage from 100 to 240v.

Switch mode power supplies can exhibit switching noise but 500R8 features linear regulation on the DC inlet to ensure that power noise and intermodulation distortion doesn't find itself on the audio rails.

Each 500 series slot features 250mA of power as well as extra headroom if a module is drawing even more current for a maximum of 2A across all 8 slots.

500R8's Power delivery is also made via a latching 4-pin connector that is designed to provide a secure connection to the chassis with protection against accidental removal.

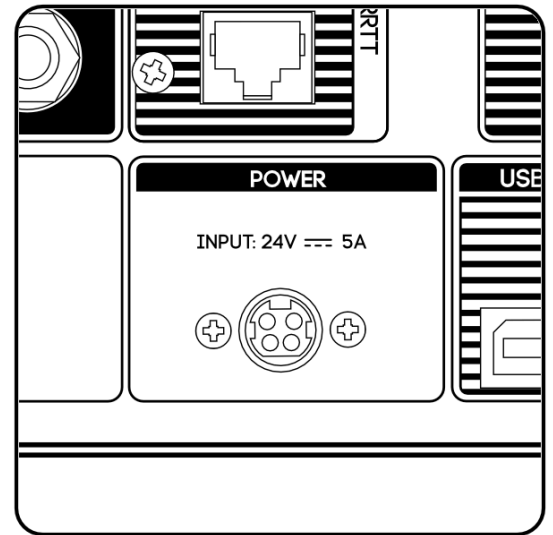

## Connecting Power

Align the metal pins and plastic locator of the plug with the power inlet. Once located, push the connector firmly into the socket whilst holding the plug's outer housing and not the cable itself.

## Disconnecting Power

Grip the body of the plug firmly and pull the body of the connector back from the socket. The plug's outer casing will pull back and release the safety latch to allow the plug to be pulled out of the socket.

### **Note:**

***Excessive strain or a sudden tug/shock to the power cable could cause damage to the cable strain relief as well as the hardware contact points associated with the power input and power supply.***

# Powering Procedures

## Powering On

First, make sure your speakers are switched off and any headphones are disconnected. Briefly tap the power button located on the top right of 500R8's front panel. The power icon will illuminate blue and you will hear soft 'clicking' as 500R8's internal relays actuate. You may now switch on your external equipment sequentially, leaving your speakers until last.

## Powering Off

First, make sure your speakers are switched off and any headphones are disconnected. Press and hold the power button for approximately 3 seconds. The power icon will deluminate and you will hear the soft 'clicking' of the relays indicating that the unit has been powered off.

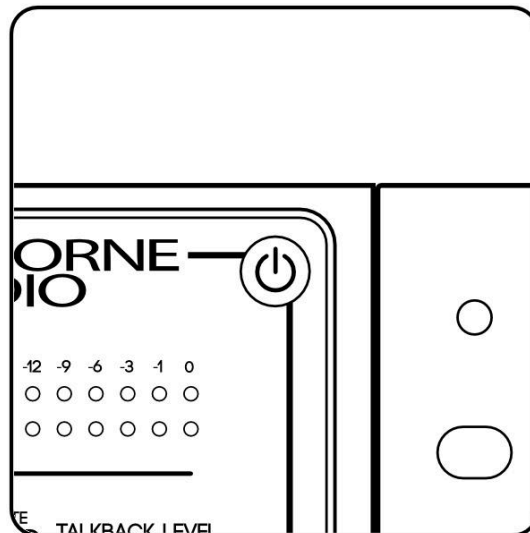

### **Note:**

***Please follow these safe powering sequences carefully in order to prevent any unwanted pops and spikes causing damage to downstream audio components including speakers and headphones.***

# Installing and Removing 500 Series Modules

## Installing Modules

1. Ensure 500R8 is powered off and the power connector has been *removed*. Wait 30 seconds before continuing.
2. Firmly touch the metal chassis of 500R8 to discharge any built-up static electricity.
3. Carefully pick up your 500 series module and locate its conductive edge into the backplane connector of 500R8.
4. Once located, push the module into place and secure the module into the rack using the supplied 4-40 screws - be careful not to over tighten and strip the screw or thread.

## Removing Modules

1. Ensure 500R8 is powered off and the power connector has been *removed*. Wait 30 seconds before continuing.
2. Firmly touch the metal chassis of 500R8 to discharge any built-up static electricity.
3. Remove the 4-40 module fixing screws and store them in a safe place for future use.
4. Firmly pull the 500 series module to release the module from the backplane connector of 500R8 and then carefully remove the module from the rack itself.

### **Note:**

***Removing or installing modules when any 500 series rack is powered on can cause irreparable damage to the backplane connector, supporting circuitry, and the 500 series module. Damage caused when "Hot Swapping" or installing/removing modules whilst 500R8 is powered on is not covered under Cranborne Audio's Warranty.***

# Hardware Setup

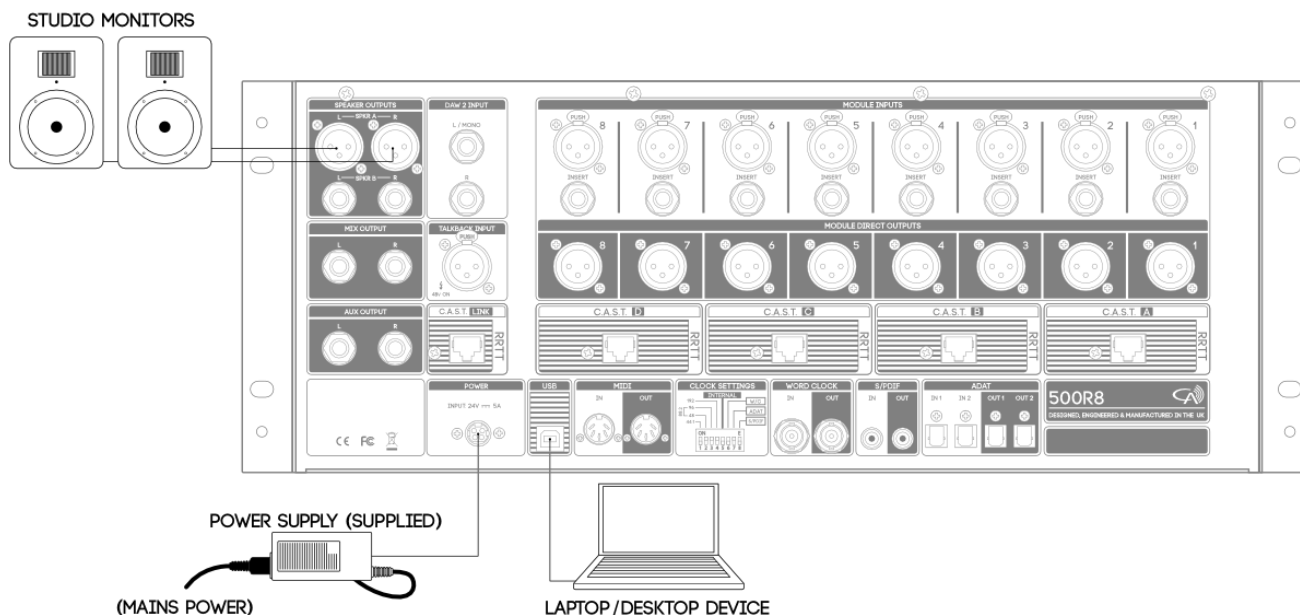

This hardware setup diagram will get 500R8 connected to your studio monitors and your laptop/desktop device ready for software installation.

- 1) Connect mains power into the external PSU supplied in 500R8's packaging and connect the power connector into 500R8's power inlet.
- 2) Connect 500R8 to an available USB port on your device using a USB type A to type B cable.
- 3) Connect the left and right Speaker A Outputs of 500R8 into the inputs of your studio monitors using balanced XLR cables.
- 4) Power On 500R8 using a brief tap of the Power button. Then Power On your studio monitors.
- 5) Configure the front panel monitor controls to match the provided diagram.

The Aux and Monitor Blend controls should be set to 12 o'clock and the DAW Select switch should be set into the up position.

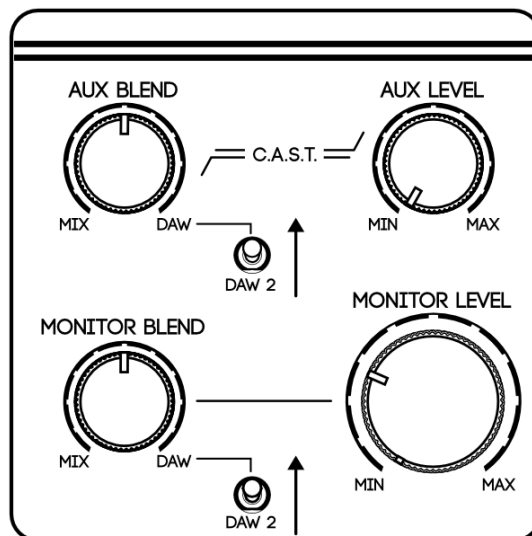

**Note:**

**Once 500R8 is connected to your speakers, the Monitor Level control may seem sensitive with small movements causing large changes in volume. In order to get the most out of 500R8's Monitor Level control, we recommend reducing the level of your studio monitors so that nominal listening level is achieved at the 12 o'clock position of 500R8's Monitor Level control.**

For a detailed guide of how to configure your studio monitors with 500R8, please follow the "[Configuring Studio Monitors With 500R8](#)" section of this manual.

# Software Setup

## Windows Configuration

If you are a Windows user, you will need to download 500R8's ASIO drivers in order for the system to detect 500R8 and make it available as an audio device in the Windows Sound Control Panel menu.

*To download the latest Windows drivers for 500R8, please visit 500R8's product page on the [Cranborne Audio Website](#).*

Once downloaded and installed, the Cranborne Audio USB Control Panel enables you to adjust the settings of the connected 500R8. When you open your DAW (Pro Tools, Cubase, Reaper etc), these settings will be overridden and configured using the Audio Preferences menu from within the DAW.

To configure 500R8 to play system sounds on your Windows device, follow the steps below:

1. Follow the Initial Setup diagram and power on 500R8 using the correct procedure detailed previously in "[Hardware Setup](#)".
2. Select the Windows Icon (displayed as a Windows Logo) on the bottom left corner of your screen, search for "Sound", and open up the 'Sound' application.
3. From the list of available audio devices, select "500R8 USB Output 1/2", select the 'Set Default' drop down menu, and select "Default Device".

Once configured, press play in any of your applications (including Spotify, Tidal, iTunes or similar), and the audio will be sent directly into 500R8's DAW return and Monitor Outputs. Increase the Monitor Level control for more volume!

**Note:**

***If you are still unable to hear audio through 500R8, please ensure that the Speaker B, Mute, and Dim keys are switched off on the monitor controller keymat. If the LED meter is indicating signal, please check that the downstream connections are correct and the speakers are switched on.***

## Sample Rate Selection In Windows

The Windows Sound Control Panel enables you to adjust the Sample Rate settings of 500R8 when it is playing system sounds such as Spotify, Youtube, and iTunes. Right-click "500R8 USB Output 1/2", select 'Properties', select 'Advanced', and select the 'Default Format' drop down menu to select your desired Sample Rate.

When a DAW (Pro Tools, Logic, Cubase, Reaper etc) is opened, the current Sample Rate is overridden and will need to be configured directly using the Audio Preferences menu within the DAW itself.

*For more details on how to adjust the Sample Rate settings from within your DAW, please consult the User Manual of your DAW of choice.*

## MacOS X Configuration

As 500R8 is Class Complaint, it will connect directly with your Apple device and be instantly recognised as an audio device from within the “Audio MIDI Setup” application.

To configure 500R8 to play system sounds, follow the steps below:

1. Follow the Hardware Setup diagram and instructions detailed in “*Hardware Setup*”.
2. Select the Spotlight Search function (displayed as a magnifying glass icon) on the top right corner of the screen, search for “Audio MIDI Setup”, and open the application.
3. Right-click 500R8 listed in the audio device column and select “Use this device for sound output”.
4. Right-click 500R8 listed in the audio device column, select “configure speakers”, and assign the left output to USB output 1 and the right output to USB output 2 using the available drop down menus either side of the speaker representations on the screen.

Once configured, press play in any of your applications (including Spotify, Tidal, iTunes), and the audio will be sent directly into 500R8’s DAW return. Use the Monitor Level control for more volume!

**Note:**

***If you are still unable to hear audio through 500R8, please ensure that the Speaker B, Mute, and Dim keys are switched off on the monitor controller keymat. If the LED meter is indicating signal, please check that the downstream connections are correct and the speakers are switched on.***

## Sample Rate Selection in MacOS

Audio MIDI Setup for macOS enables you to adjust the Sample Rate settings of 500R8 when it is playing audio from Spotify, Youtube, and iTunes. Simply select the ‘Format’ drop down menu to display the possible Sample Rates from 44.1 to 192kHz.

When a DAW is open on the connected device, the Sample Rate will need to be configured using Audio MIDI Setup as well as the DAW itself. macOS Core Audio requires that sample rates above 88.2kHz and 176.4kHz are selected from within Audio MIDI Setup before they are available for selection in the DAW.

*For more details on how to adjust the Sample Rate settings from within your DAW on macOS, read the [“High Sample Rates On macOS”](#) section of this manual.*

## Configuring 500R8 in Your DAW

In order for 500R8 to operate as intended within your chosen DAW, the Stereo/Monitor Output of your DAW’s internal mixer must be configured to send audio out of USB output 1 and 2 by default. These USB paths correspond with 500R8’s Monitor Controller and will allow you to access 500R8’s DAW Returns and 500 series slots independently.

*Every DAW handles Monitor Output assignments differently. For instructions on how to reassign the Monitor Output, please consult the User Manual of your chosen DAW.*

# Feature Overview

## 500 Series Rack

The centrepiece of 500R8 is its 8-slot, high-current 500 series rack. Each slot features an abundance of I/O located on the rear panel that allows analogue input, insert, and output connectivity per-slot much like a standard standalone 500 series rack.

Each 500 series slot is tightly integrated with 500R8's converters and USB interface for recording each inserted 500 series module as well as playing back USB sources through each 500 series module. Each 500 series slot features front-panel switches that determine its input source and enable deeper integration with 500R8's Summing Mixer and USB Audio Interface.

### Module Inputs

Each 500 series slot features a dedicated balanced XLR input that is used to connect analogue signals into each 500 series module. The module input XLR can accept mic, line, or hi-z sources depending on what module is inserted and it's input sensitivity options.

**Note:**

***In instances where the 500 series module features its own XLR/Jack input on the front panel, it is advised to check with the manufacturer of the module to determine which input should be used for your desired application.***

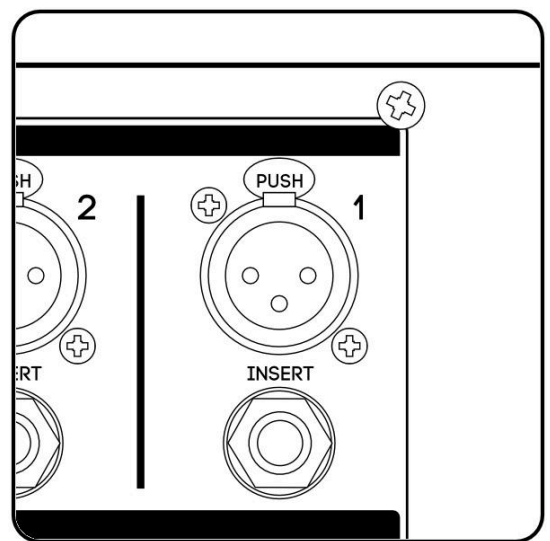

### Inserts

Each 500 series slot features a dedicated Insert connection that utilises a TRS jack socket in a similar configuration that is commonly found on mixing consoles. This Insert point allows external audio equipment such as 19" rackmount compressors and EQs to be inserted into the audio path and recorded. The Insert is situated after the 500 series slot but before the ADC and USB recording path in the signal which means that the effect Inserted will be heard on the USB recording, Module Direct Outputs, and internal Summing Mixer.

#### **Insert Wiring**

Tip= Send, Ring= Return, Sleeve= Ground

To connect external audio equipment into 500R8 via its Insert, you will need to use a standard Y-split or insert cable that splits a TRS jack into 2 separate connections - a send and return - to two mono ¼ jacks or male/female XLRs.

The 'Send' connector (Tip + Sleeve) should be connected to the input of your outboard equipment and the 'Return' connector (Ring + Sleeve) should be connected to the output of your outboard equipment.



**Note:**

**500R8 does not feature a dedicated switch to engage the insert point and so to fully bypass the insert point during recording/mixing you will need to bypass the inserted effect itself or disconnect the insert point.**

## Module Direct Outputs

Each 500 series slot features its own Module Direct Output that is a fully balanced XLR line-level output of each 500 series module that can be used to connect to external A/D converters or advanced monitoring systems. The Module Direct Outputs are positioned PRE the Mix Level controls for each 500 series slot and mirror what is sent into the DAW via USB.

You can also use the Module Direct Outputs to send audio from one slot to another by simply using an XLR cable.

**Note:**

**For advanced patching combinations, you can connect the module inputs and outputs of 500R8 to a patchbay to allow convenient re-ordering of modules as well as advanced channel strip creation without accessing the rear panel.**

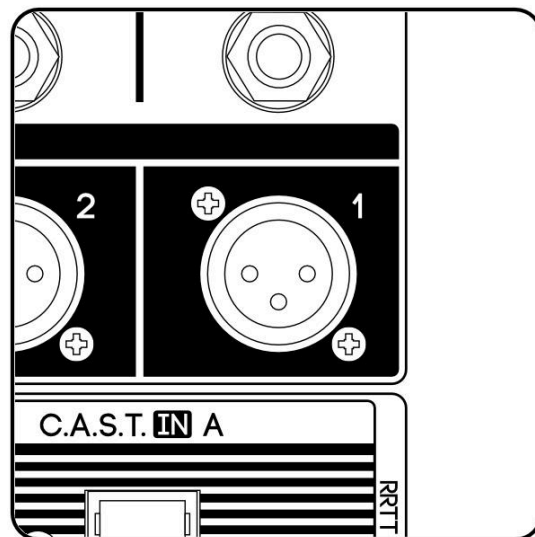

## Slot Bypass Switch

The Slot Bypass switch is located on the backplane connector by each 500 series slot and can be used to bypass the slot if no 500 series modules are inserted. Bypassing the slot allows you to connect line-level sources such as external mic preamps and effects units directly into the rear panel inputs of 500R8 and record those signals directly into the DAW via USB.

The Slot Bypass switch is available per-slot which allows you to occupy some of 500R8's 500 series slots with modules whilst using the others to record line-level sources.

The Module Source, Insert, Module Direct Output, and Summing Mixer features function as normal for each slot that has the Slot Bypass switch active.

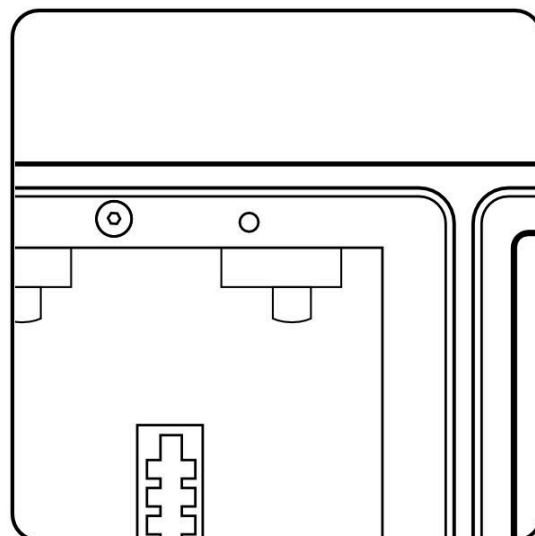

## Source Switch

Each 500 series slot on 500R8 features a Source Select switch on the front panel that is used to determine which audio signal is sent into the input of the inserted 500 series module.

These source options include:

### **C.A.S.T.**

This configures the 500 series slot to receive signal via the corresponding C.A.S.T. inputs. There are 4 C.A.S.T. Inputs on the rear panel and they correspond to pairs of 500 series slots. This port is intended for expansion via C.A.S.T. enabled breakout boxes.

*For a detailed explanation of C.A.S.T., please read the "[C.A.S.T. IN A, B, C, & D \(RRTT\)](#)" section of this manual.*

### **ANLG**

This configures the 500 series slot to receive signal via the corresponding rear Module Input XLR connection.

### **USB**

This configures the 500 series module to receive signal via the corresponding USB channel from 500R8's built-in USB Audio Interface.

*For a detailed explanation of the USB routing for each slot, please read the "[USB Channel Labelling And Assignments](#)" section of this manual.*

### **Note:**

**Switching between source selections whilst monitoring the 500 series slots can cause audible "clicks and pops" through your audio system depending on what module is inserted and its input/output gain. Please take care and reduce the listening volume prior to switching the Source Selector switch.**

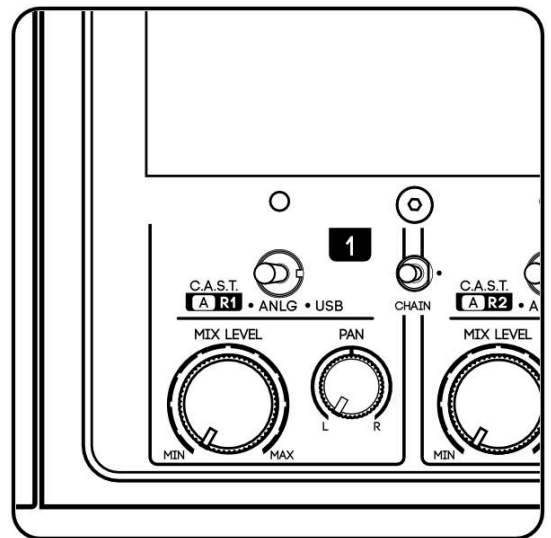

## Stereo Link Jumper

The Stereo Link Jumper connects Pin 6 on adjacent 500 series connectors to allow for compatible Dual-Mono or Stereo Compressor modules to monitor the same sidechain signals and compress evenly across the stereo image.

To enable the Stereo Link feature, remove the module and carefully move the black plastic jumper fitted to the right jumper leg and refit it over both visible metal legs.

**Note: Only odd-to-even slots can be linked together for stereo operation ( 1-2. 3-4. 5-6. 7-8)**

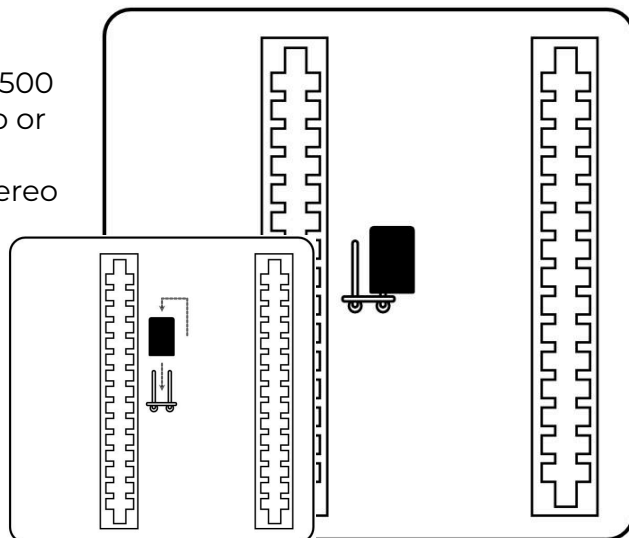

## Chain Switch

The Chain Switch overrides the Source Select switch and sends the audio signal from one 500 series slot into the next 500 series slot. This can be used to create chains of modules for advanced tonal shaping and channel strip creation during tracking and mixing.

Slots can be chained from left to right and can be created independently from one another for a total of 4 chains of 2, 2 chains of 4, 1 chain of 8, or any configuration in between.

### **Note:**

**When chaining channels, all existing Module Direct Outputs and USB outputs work as normal for all contributions in the chain. For example, if you have a mic preamp in slot 1, an EQ in slot 2, and a compressor in slot 3, you can record the USB output of slot 3 to record the summed result of all 3 modules, record the USB output of slot 2 to record just the preamp and EQ, or record the USB output of slot 1 to print the dry effect. You can also record all 3 parts of the chain simultaneously for more flexibility later on in the mix stage.**

## 500 Series Signal Flow

Each 500 series slot is connected to multiple sources and destinations that facilitate all of the complex internal recording and mixing aspects of 500R8. To better understand where each slot is positioned in the signal path in relation to its converters, the below diagram displays a rough overview of the signal flow of one 500 series slot to its possible destinations.

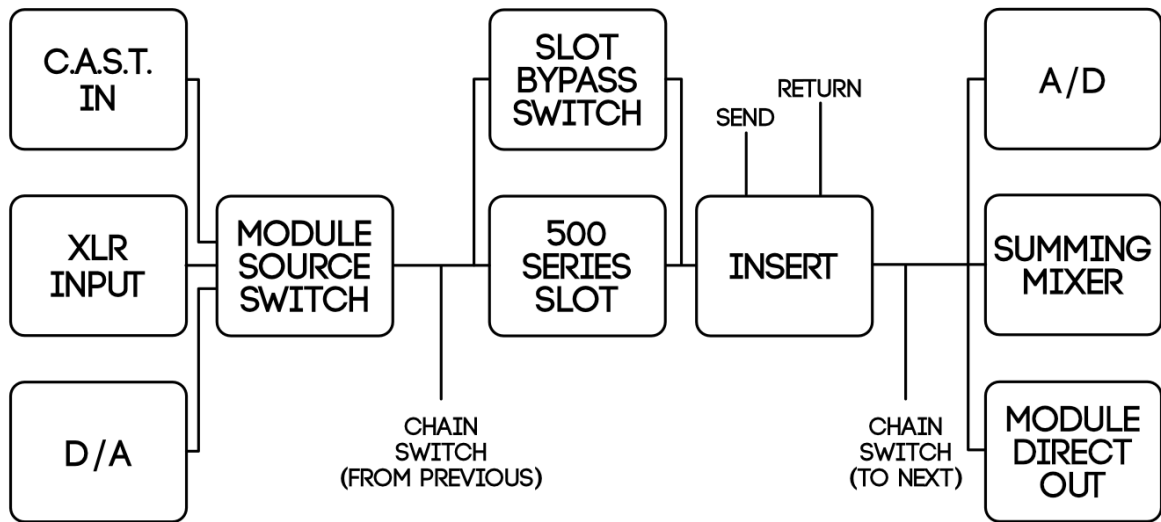

**Note:**

***The output of each module is sent to 3 destinations at all times irrespective of the Module Source or Chain switches.***

## Summing Mixer

500R8 features a high-headroom 8-to-2 analogue Summing Mixer that can be used to sum eight analogue audio paths from the 500 series slots into a single stereo track for recording back into your DAW.

You can use the eight 500 series slots as well as their insert points to apply analogue colouration and processing onto your audio tracks/stems before they are summed using the Summing Mixer. The input sources are determined by the source switches below each 500 series slot to allow for summing Analogue, C.A.S.T., or USB sources.

The Summing Mixer has a headroom of +24dBu to allow you to drive transformer/valve-based equipment to get the most range of colouration available without fear of overdriving the Summing Mixer and clipping 500R8's dedicated Summing Mixer A/D converter.

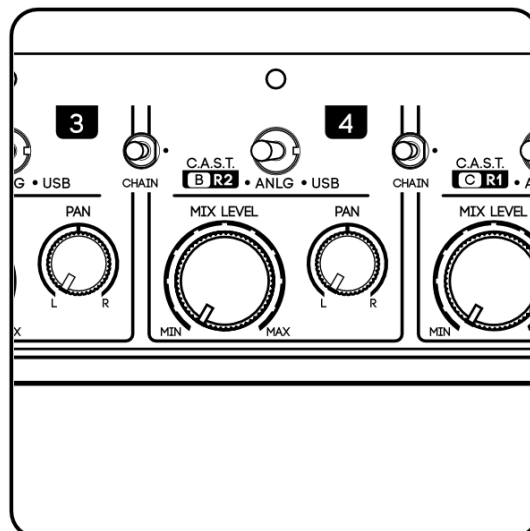

### Mix Level & Pan

The Mix Level and Pan controls are used to balance the volume and pan position of each 500 series slot within the Summing Mixer.

#### **Mix Level**

Adjusts the level of the 500 series slot into the Summing Mixer. Mix Level is a variable control with a range of  $-\infty$  to +10dB

#### **Pan**

Adjusts the pan position of the 500 series slot into the Summing Mixer. Pan is a variable control with a centre detent that operates a -4.5dB pan law.

### Summing Mixer Outputs

The stereo output of the Summing Mixer is sent to two different locations internally for dual recording in different circumstances.

#### **USB Input 1/2**

The Summing Mixer and its stereo output is sent directly into its own dedicated stereo A/D converter that is used to record the stereo mix into your DAW via 500R8's USB Audio Interface. The Summing Mixer output corresponds with USB Input channels 1/2.

#### **Mix Output**

The Summing Mixer and its stereo output is sent directly to two dedicated ¼" jack outputs on the rear panel labelled 'Mix Output'. These connections can be used to send the summed mix onwards to 3rd party converters or monitoring systems.

The Summing Mixer does not feature its own master volume control. This in order keep the analogue path as pure as possible and retain the maximum headroom and lowest THD. Use the individual Mix Level and Pan controls for each 500 series slot to reduce the overall level of the Summing Mixer and prevent clipping its A/D converter or internal signal paths.

**Note:**

**By turning the Monitor Blend control fully anti-clockwise to its Mix position, the 28 segment LED meter will display the input level status of the stereo A/D converter for the mix bus - allowing you to set the ideal level for the maximum signal-to-noise ratio when printing the mix into the DAW. Using the Mix Level and Pan controls, set your summed mix to be as 'hot' as possible without clipping the meter to achieve the best A/D performance.**

## Summing Mixer Expansion Via C.A.S.T. LINK

The C.A.S.T. LINK port on the rear panel of 500R8 can be connected to the corresponding C.A.S.T. LINK port on 500ADAT to double the channel count of available analogue summing from 8 to 16 channels.

The C.A.S.T. LINK connection receives a stereo analogue signal (RR) from 500ADAT whilst simultaneously transmitting a stereo analogue signal (TT) via the same shielded Cat5 cable. Those four audio paths are broken down as follows:

### Receive 1 + 2

Receives 500ADAT's Stereo Summing Mixer Outputs

The two receive paths of the C.A.S.T. LINK connector featuring 500ADAT's Summing Mixer output are combined with 500R8's own Summing Mixer and sent directly to USB Inputs 1/2 and physical Mix Outputs of 500R8. In this configuration, 500ADAT doubles the system's Summing Mixer channels to 16.

The same two receive paths of the C.A.S.T. LINK connector featuring 500ADAT's Summing Mixer output are also sent into 500R8's Aux and Monitor Blend controls to enable musicians to monitor all inputs connected to both devices. In this configuration, 500R8's Aux and Monitor Blend controls can be turned anti-clockwise to their 'Mix' positions to monitor both 500R8's and 500ADAT's Summing Mixers simultaneously.

### Transmit 1 + 2

Transmits 500R8's Stereo Aux Bus (*Post Aux Blend control, Post Talkback, Pre Aux Level*)

The two transmit paths of the C.A.S.T. LINK connector feature 500R8's Aux Mix and are sent into 500ADAT's Aux 1 and Aux 2 Blend controls to enable musicians connected to 500ADAT to monitor 500R8's Summing Mixer and blend that with 500ADAT's local Summing Mixer.

The transmit paths feature 500R8's Aux bus *post* Aux Blend control and also include 500R8's Talkback signal to enable the engineer to communicate with musicians connected to 500ADAT using 500R8's Talkback facility.

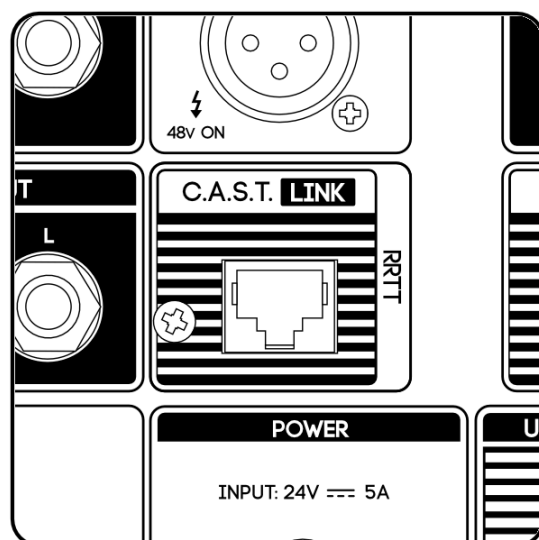

## Artist Monitoring Section

There are two main monitoring paths on 500R8; one labelled Monitor (designed for the engineer) and the other labelled Aux (designed for the musician). Each path has its own Blend controls that are used to adjust the balance between the analogue Summing Mixer and incoming DAW returns via USB.

500R8 also has the option to send an alternate stereo DAW return (labelled DAW 2) into the monitoring path.

500R8 features dedicated reference-quality Aux and Monitor headphones outputs on the front panel as well as various line output options on the rear panel to distribute monitoring wherever it is needed.

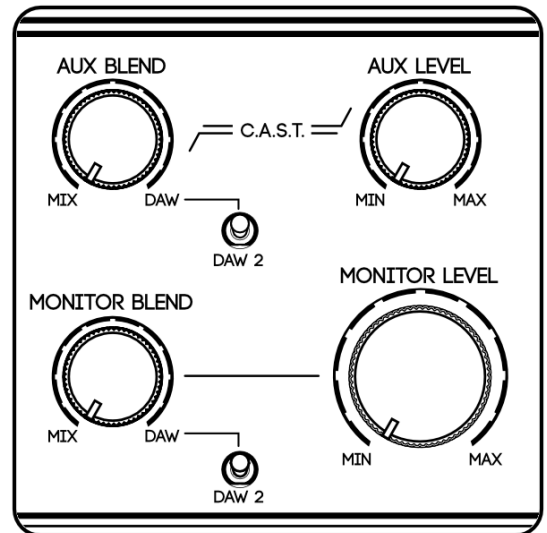

### Aux/Monitor Blend

The Blend controls are the main contributing factor for creating great sounding artist monitor mixes. These blend controls adjust the balance of the mix between two different elements:

#### **Mix**

Comprises of the analogue Summing Mixer and is created using the Mix Level and Pan controls located below each 500 series slot. The Mix is typically composed of live sources but can also feature channels being sent into the modules via USB.

#### **DAW**

Comprises the playback that is generated from within the DAW and sent into 500R8 via USB. DAW is typically composed of pre recorded elements, click tracks, and VSTs from within the connected DAW but can also feature live instruments by utilising software monitoring within the DAW.

The Blend controls can be set anti-clockwise to listen to the Summing Mixer directly, clockwise to listen to the DAW input directly or anywhere in-between to create a custom balance of the two sources.

### DAW Select Switch

The DAW Select switch determines which of 500R8's DAW returns are sent into the Aux and Monitor Blend controls. DAW or DAW 2 can be engaged for the Aux or Monitor busses independently. The DAW and DAW 2 returns are accessed using separate stereo USB outputs from within the DAW:

#### **DAW**

Corresponds with USB Outputs 1/2 (all sample rates)

#### **DAW 2**

Corresponds with USB Outputs 29/30 (44.1/48kHz)

## DAW 2 Input Jacks

The DAW 2 Input jacks on the rear panel of 500R8 can be used if the user would like to integrate 500R8 with their own converters rather than use its built-in USB interface.

Audio connected to the DAW 2 Input jacks is summed with the DAW 2 USB playback (USB Outputs 29/30) and sent into the Aux and Monitor blend controls to achieve more complex mixing and routing possibilities if required.

The DAW 2 jacks are unbalanced connections to facilitate the L/Mono normalling circuit and enable the analogue DAW 2 Input to operate in mono if just the left jack is inserted. In the same manner as the DAW 2 USB returns, the analogue DAW 2 Input jacks can be engaged by using the front panel DAW Select switches beside the Aux and Monitor Blend controls.

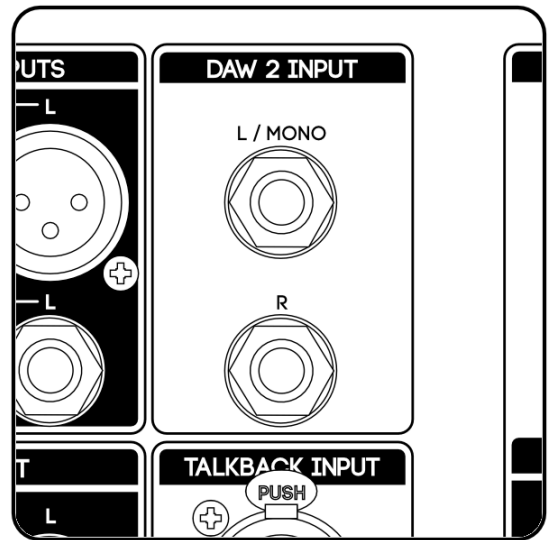

### **Note:**

**Please consult the user manual of your external playback device to find out the best procedure for connecting its balanced outputs into the DAW 2 unbalanced 1/4" jack inputs.**

## Aux/Monitor Level

### **Aux Level**

Adjusts the overall level of the Aux bus including the Aux Headphone output and the Aux Output jacks on the rear panel.

### **Monitor Level**

Adjusts the overall level of the Monitor bus including the currently active Speaker Outputs (A or B) as well as the Monitor Headphones output.

## Aux Outputs

The Aux Bus is fed to multiple locations to enable deeper connectivity with monitoring systems depending on your desired use case:

### **Aux Headphones**

Beneath the artist monitoring section is a dedicated Aux Headphone output. This headphone output is driven after the Aux Blend and Aux Level controls and is primarily used when a musician is placed in the control room and a silent monitoring environment is required.

### **Aux Outputs**

The Aux Bus also features dedicated stereo line outputs on the rear panel which can be used to drive monitor wedges, monitor distribution systems, or IEM systems. These outputs are also driven after the Aux Blend and Aux Level controls on the front panel.

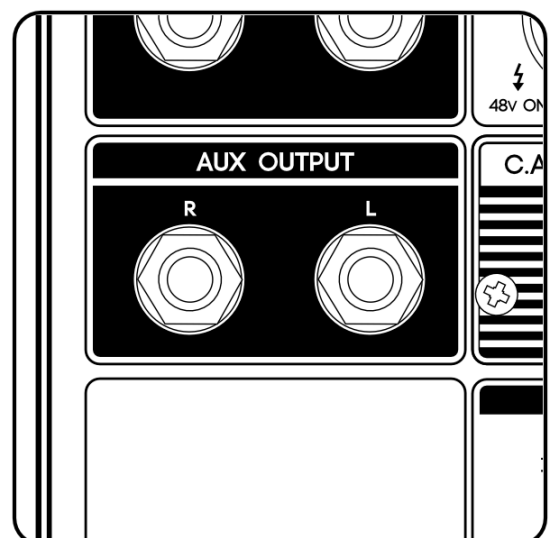



# Monitor Controller

500R8 features a complete Monitor Controller section that is the hub for all of your Speaker, Headphones, and Talkback duties when mixing and recording. All major functions are directly accessible on the front panel for quick navigation and are produced on a rubber keymat for button longevity, increased visual feedback in dark environments, and improved tactile feel.

## Meter

The 28-segment meter on 500R8 displays the level present on the Monitor Bus and is positioned in the signal path between the Monitor Blend and Monitor Level controls to enable high-resolution metering of the analogue signal path.

The meter is labeled in dBFS and corresponds with the operating level of 500R8's A/D and D/A converters to allow for high-resolution metering of the conversion process to avoid clipping during recording and playback. The 0dBFS point on the meter corresponds to the A/DD/A converters' clipping point of +24dBu.

**Note:**

**Turn the Monitor Blend control anti-clockwise to the Mix position and the meter displays the level of the Summing Mixer being sent into its A/D converter. If the meter is clipping at 0dBFS then the Summing Mixer needs to be attenuated using the Mix Level controls beneath each 500 series slot.**

**Turn the Monitor Blend control clockwise to the DAW position and the meter displays the level of the audio incoming via the DAW return and its dedicated D/A converter. If the meter in this configuration is clipping at 0dBFS then the DAW output needs to be attenuated.**

## SPKR A/B Key

500R8 has two sets of speaker outputs that can be used to connect two separate sets of speakers for main and reference monitoring.

The SPKR A/B key on the front panel toggles between which Speaker Outputs are currently active. The key is latching and when engaged, sends the Monitor Bus through to the stereo pair of Speaker B jacks. When the switch is disengaged, the Monitor Bus sends through to the Speaker A outputs.

Switching between multiple speakers allows an engineer to make better mix decisions during the mixing phase by listening and comparing the mix on two different sets of monitors each with their own unique frequency responses and characters.

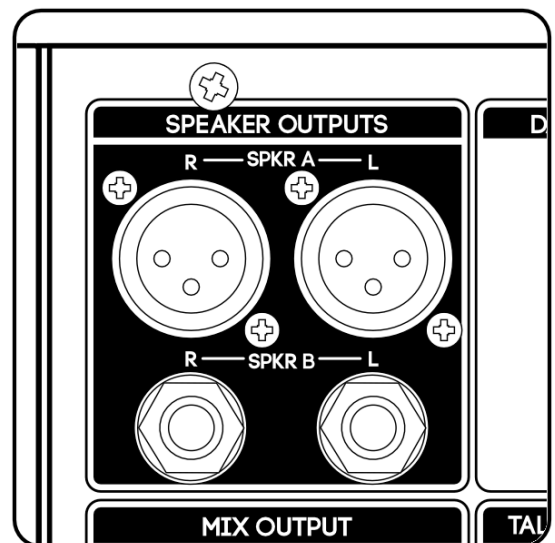
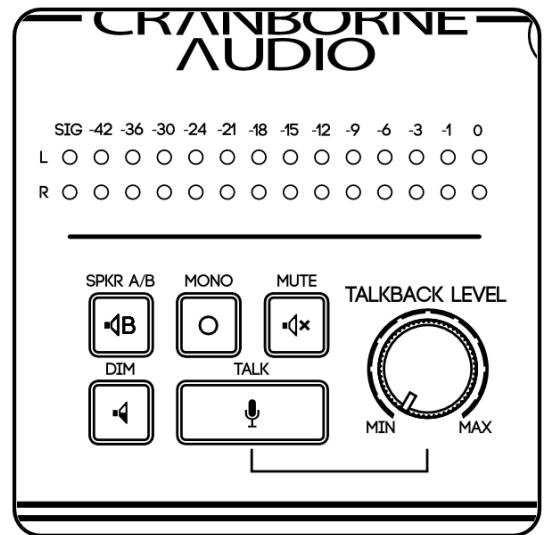

The Speaker A path and its dedicated balanced XLR outputs have a maximum output level of +24dBu to provide clean headroom and parity with 500R8's +24dBu internal audio circuit circuitry. The Speaker B path and its dedicated impedance balanced ¼" jack outputs have a maximum output level of +18.5dBu.

**Note:**

**Exercise caution when connecting speakers to 500R8 and ensure that they are able to accept the high output level of the Speaker A Outputs to avoid causing damage to their internal components. For information on how to setup your speakers correctly with 500R8, follow the details in the "[Configuring studio monitors with 500R8](#)" section of this manual.**

## Mono Key

The Mono key on 500R8 sums the stereo information of the Monitor Bus and sends the mono signal out of the left and right outputs of the currently active speakers (A or B). The Mono key is useful to check how your mix will translate on mono systems as well as small devices that do not accurately reproduce stereo imaging such as phones and small bluetooth speakers.

The Mono key also affects the Monitor Headphones output for checking mono compatibility with headphones.

## Mute Key

The Mute key overrides all other speaker functions and disables the Speaker A and Speaker B Outputs of 500R8.

The Headphone Outputs remain unchanged in this operation and Talkback/Mono buttons continue to function as normal into the Aux and Monitor Headphone Outputs.

## Dim Key

The Dim key attenuates the Monitor Bus by 12dB in order for the control room to be temporarily dimmed in volume for conversation. The Dim key affects both the currently active Speaker Outputs (A/B) as well as the Monitor Headphones output. Using the Dim key rather than the volume control allows the engineer to have quick access to two distinct listening levels without reaching for the Monitor Level control.

## Monitor Headphones Output

The Monitor Headphones Output is used primarily by the recording/mixing engineer for mix referencing or silent monitoring using headphones.. The Monitor Headphone Output reflects exactly what is being sent out of the Speaker Outputs (A or B) and is designed to be used instead of the speakers and not simultaneously with the Speaker Outputs.

The Monitor Headphones Output does not feature its own dedicated headphone level control and instead uses a custom-designed fixed-level, high-power, and low-noise headphone amplifier that is controlled in level by using the Monitor Level control.

**Note:**

**Only connect headphones to 500R8's headphones outputs. Unbalanced and/or line connections could short leg to ground and cause a spike in power consumption. Any damage caused to the unit as a result of unsupported connections is not covered under the Cranborne Audio warranty.**

# Talkback

500R8 features a comprehensive Talkback system that can be used to communicate with musicians located around the studio space.

The Talkback signal is sent to 500R8's Aux Headphones and Output jacks as well as the C.A.S.T. connectors to enable communication with all musicians connected to 500R8 via C.A.S.T. breakout boxes.

## Talkback Input

The Talkback input is located on the rear panel of 500R8 and features an XLR connection that can be connected to an external microphone to access the talkback features.

The Talkback Input is a fixed-gain mic preamp with 30dB of gain and 48v phantom power enabled to enable dynamic or condenser microphones to be used.

## Talkback Level

The Talkback Level control is a variable gain control with 30dB of level on tap that is used to set the level of the talkback signal globally to its multiple destinations.

## Talk Key

The Talk key can operate in two ways, quick press for a latching operation, press and hold for a momentary "push-to-talk" operation. When active, the Talk key is used to activate the talkback feature and send the talkback signal onwards to its associated destinations.

When the Talk key is active, the Aux Bus mix is ducked by 12dB in volume to allow the musicians to hear the Talkback over the top of the Aux mix.

The Talk key also temporarily enables the Speaker Dim function to reduce the volume in the control room and achieve a more intelligible talkback signal through the talkback microphone.

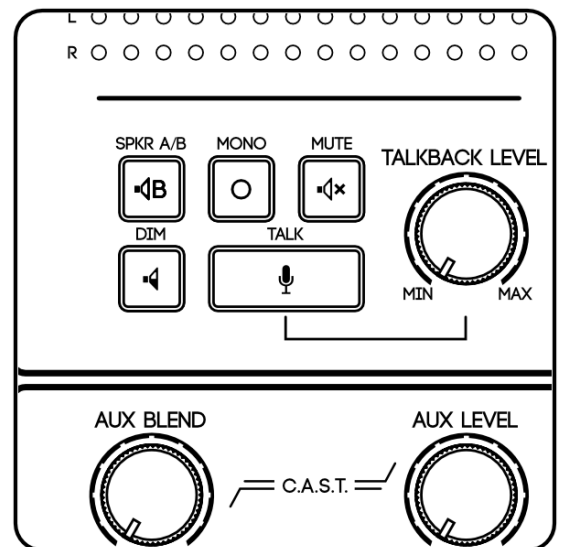
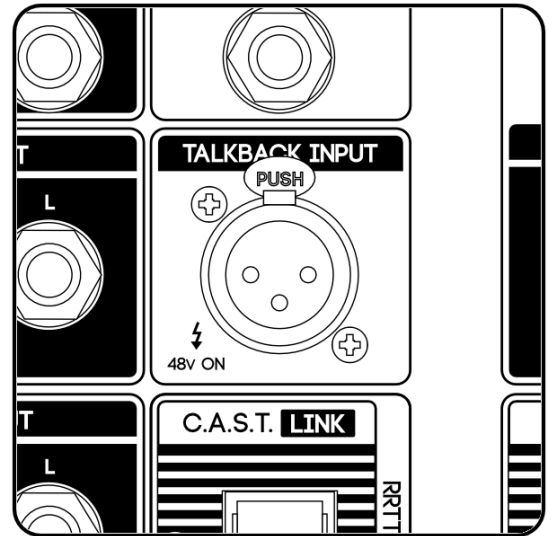

# USB Audio Interface

The USB audio interface on 500R8 is a 28-in/30-out, USB 2.0 audio interface that enables connection to PC, Mac, or Linux devices for recording and playback.

USB 2.0 provides ample bandwidth and speed to perform all of 500R8's recording and monitoring duties at extremely low buffer settings and high sample rates. 500R8's implementation of its USB drivers and firmware enables extremely lightweight and efficient interfacing whilst remaining the most stable and widely accepted standard on modern and legacy machines.

**Note:**

**USB 3.0 type C ports such as those found on Mac devices are backwards compatible with 500R8 provided USB adapters are used that do not truncate the USB stream.**

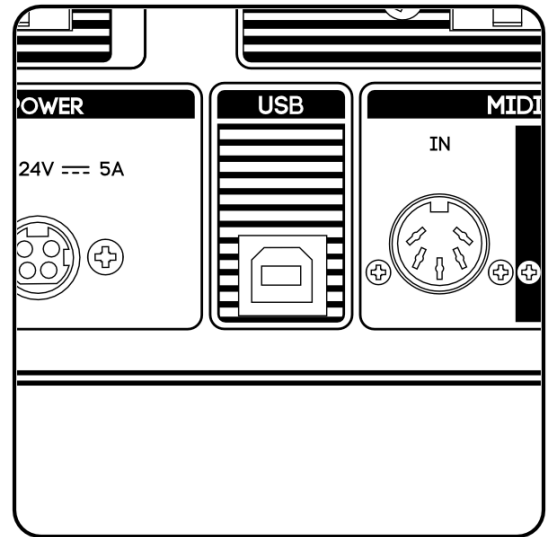

## USB Inputs

500R8 sends up to 28 sources into the connected DAW via the built-in USB Audio interface:

USB Inputs	Channel Size	Description	Notes
3-10	8	500 Series Slot Outputs	Post Insert
1-2	2	Summing Mixer Outputs	
11-26	16	ADAT Inputs	
27-28	2	S/PDIF Inputs	

## USB Outputs

500R8 receives up to 30 sources from the connected DAW via the built-in USB Audio interface:

USB Outputs	Channel Size	Description	Notes
3-10	8	500 Series Slot Inputs	
1-2	2	DAW Outputs	
11-26	16	ADAT Outputs	
27-28	2	S/PDIF Outputs	
29-30	2	DAW 2 Outputs	

## USB Channels At Higher Sample Rates

As 500R8's operating sample rate is increased to 88.2kHz and above, the USB channel count is reduced in size to facilitate the higher data transfer.

Below is a graph detailing the USB channel size and restrictions of 500R8 at all sample rates:

Sample Rate (kHz)	500 Series Slots	Summing Mixer	ADAT	S/PDIF	DAW 1	DAW 2	Total (I/O)
44.1	✓	✓	✓ (16ch)	✓	✓	✓	28/30
48	✓	✓	✓ (16ch)	✓	✓	✓	28/30
88.2	✓	✓	✓ (8ch)	×	✓	×	18/18
96	✓	✓	✓ (8ch)	×	✓	×	18/18
176.4	✓	✓	×	×	✓	×	10/10
192	✓	✓	×	×	✓	×	10/10

## High Sample Rates On macOS

In order to record/playback at high Sample Rates (88.2kHz and above), Apple's Core Audio stack requires the desired 'alternate setting' be selected from within Audio MIDI Setup to allow the DAW to use the desired sample rate.

To change the alternate setting using Audio MIDI Setup:

1. Select the Spotlight Search function (displayed as a magnifying glass icon) on the top right corner of the screen, search for "Audio MIDI Setup", and open the application.
2. Select 500R8 listed in the audio device column.
3. Select your desired Sample Rate using the 'Format' dropdown box.
  - a. To set your DAW session to record at a Sample Rate of 96kHz or below, Audio MIDI setup needs to be configured to 96kHz or above.
  - b. To set your DAW session to record at a sample rate of 192kHz or below, Audio MIDI setup needs to be configured to 192kHz.

**Note:**

***If your DAW is open, the Sample Rate may oscillate between sample rates when making changes, however you will still be able to change the project sample rate to your desired setting from directly in the DAW.***

4. Return back to your DAW and select your desired recording sample rate.

## ADAT

ADAT is a tried and tested digital audio protocol that facilitates I/O expansion via optical cables with Toslink connectors. 500R8 implements an in-depth integration of ADAT with SMUX II to allow recording at high sample rates.

2 ADAT Input and 2 ADAT Output ports enable expansion of up to 16 channels at 44.1/48kHz, or 8 channels at 88.2/96kHz.

The below graph details the routing of ADAT I/O between the 4 ports including the tradeoffs between sample rate and I/O count:

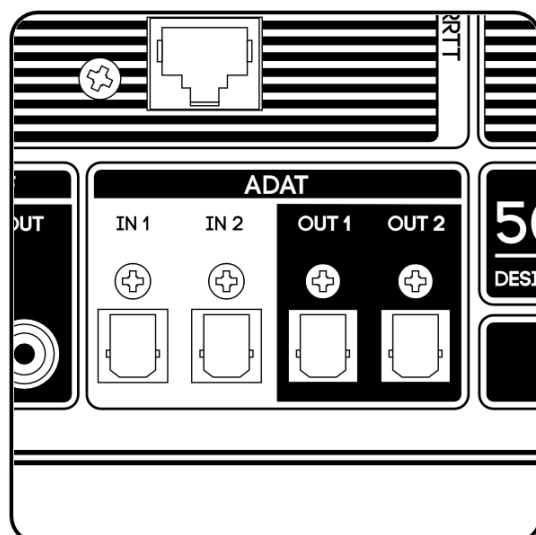

### ADAT Channels At Higher Sample Rates\*

Sample Rate	<u>In 1</u>	<u>In 2</u>	<u>Out 1</u>	<u>Out 2</u>
44.1/48kHz	Ch 1 - 8	Ch 9 - 16	Ch 1 - 8	Ch 9 - 16
88.2/96kHz	Ch 1 - 4	Ch 5 - 8	Ch 1 - 4	Ch 5 - 8

**\*The full ADAT channel count at 176.4 and 192kHz will be available in a forthcoming firmware update.**

## S/PDIF

S/PDIF (or Sony/Philips Digital Interface) is an audio protocol that transports 2 channels of audio down an unbalanced coaxial cable with RCA connectors. S/PDIF is based on the AES3 standard and is compatible with AES3 connections via XLR provided the correct cable is used (XLR to RCA).

500R8 features a pair of S/PDIF inputs and outputs that are able to send and receive audio directly to and from the USB interface and DAW whilst bypassing an extra stage of AD/DA conversion.

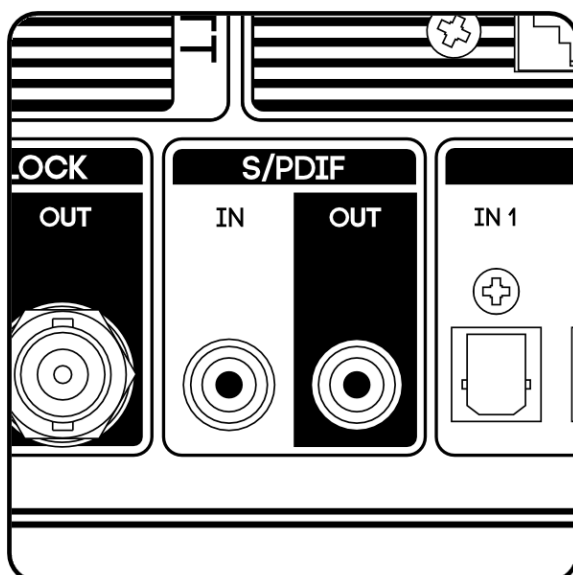

## Low-Jitter Internal Clock

500R8 features an extremely accurate internal clock that is the governor for all of the AD/DA conversion throughout the unit. This clock is responsible for making sure all of the internal converters are in sync to prevent distortion artifacts, grittiness, and to improve stereo imaging.

It is not uncommon to find professional studios utilising a standalone master clock to sync all peripheral equipment. The facts and figures of 500R8's built-in clock are good enough to stand up against - and in some cases exceed - the performance of expensive standalone units.

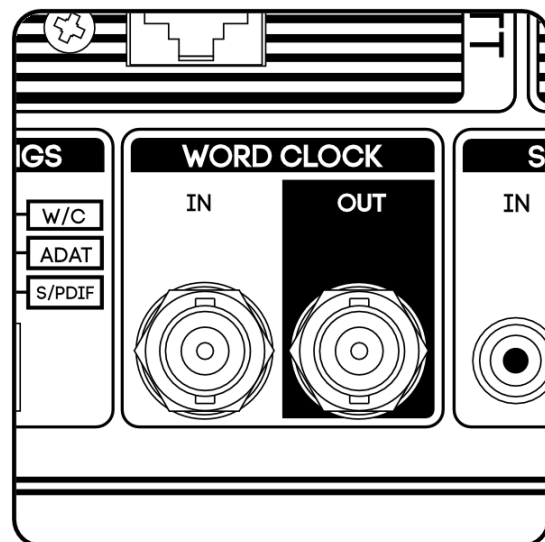

### Word Clock Input

The Word Clock Input connector is used to slave 500R8 from an external clock source via a BNC cable. In this application, word clock must be connected to the Word Clock Input port of 500R8 and 'Word Clock' set to the default clock source from within your DAW or system preferences menus.

**Note:**

***When slaving 500R8 from an external clock, its own internal clock syncs to the incoming timing information and recovers its own improved clock. For the best results and the highest quality conversion, we recommend using 500R8 as the clock master of your studio.***

### Word Clock Output

The Word Clock Output connector sends out 500R8's current timing information in order to slave other digital units off of 500R8's internal clock. If 500R8 is slaving from another source, the Word Clock Output passes through the recovery clock information to sync further downstream equipment.

**Note:**

***When possible use a clock distribution device to distribute word clock accurately and reliably to all devices. When possible, use 500R8 as the master clock to your system.***

## Clock Source

500R8 can be integrated into your studio as either a master or slave device by configuring its Clock Source using the software control panel for your chosen device - Cranborne Audio's USB Control Panel for Windows machines, or Audio MIDI Setup for macOS.

The Clock Source can be assigned to 5 different options to allow for maximum integration into your studio space. These options are as follows:

### **Internal Clock (default, recommended)**

Allows 500R8 to generate its own accurate and low-jitter clock from its internal clock. This setting should be used when 500R8 is connected to a device via USB and is intended to be used as the clock master to the system.

### **USB Recovered**

Allows 500R8 to slave from a device connected to its USB port. This setting should be used if you have multiple audio interfaces connected to the same machine that you would like to be clocked from USB.

### **ADAT Recovered**

Allows 500R8 to slave from a device connected to the ADAT stream. This setting should be used if you wish to slave 500R8 to a device that is connected via ADAT.

### **Word Clock**

Allows 500R8 to slave from a device connected to the Word Clock Input connector. This setting should be used if you need to clock 500R8 off of an external clock master connected via a word clock BNC cable.

### **S/PDIF Recovered**

Allows 500R8 to slave from a device connected to the S/PDIF Input connector. This setting should be used if you wish to slave 500R8 to a device connected via S/PDIF..

## Configuring Clock Source on Windows

To configure 500R8's Clock Source on Windows devices, simply open up the Cranborne Audio USB Control Panel application, open the "Settings" tab, and select your desired clock source from the drop down list of available clock Sources.

## Configuring Clock Source on macOS

To configure 500R8's Clock Source on macOS devices, simply open up Audio MIDI Setup, select 500R8 from the list of available audio devices, and select your desired clock source from the drop down list of the available clock Sources.



## Clock Settings DIP switch

The Clock Settings DIP switch is not operational on v1.3 firmware.

## Standalone Mode

If using 500R8 without a DAW, the internal clock is set to 48kHz.

## MIDI I/O

500R8 features a full complement of MIDI I/O integration via standard 5-pin DIN connections. MIDI allows live performance and synth-based workflows to integrate seamlessly with 500R8. 500R8 essentially converts MIDI information and sends it via USB into the host device for recording of midi note or program change information.

The MIDI output can be used to fire-off note or program change information to external equipment for MIDI instruments and integrating synths into your workflow.

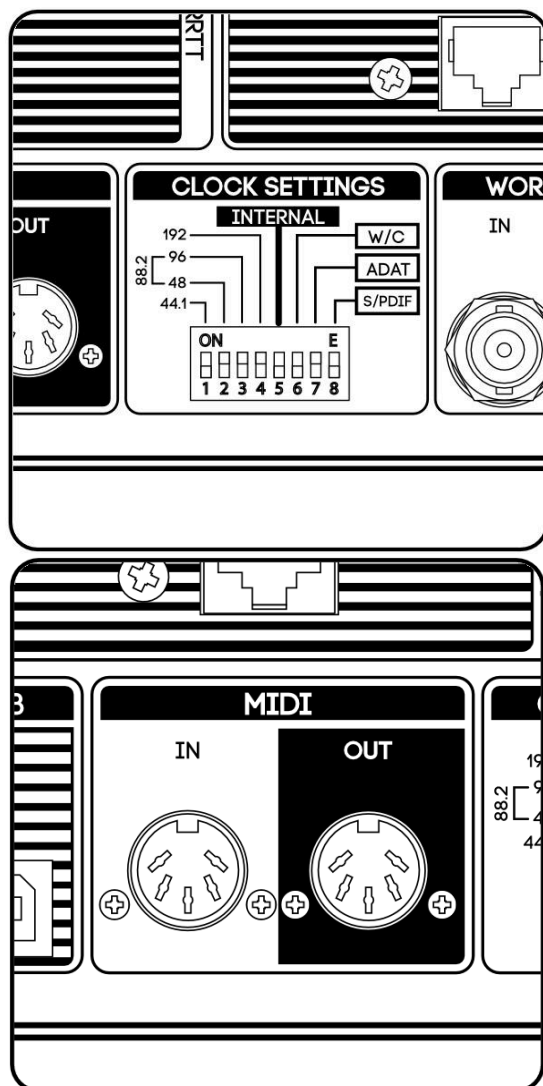

# C.A.S.T.

C.A.S.T. stands for Cat5 Analogue Snake Transport. C.A.S.T. is Cranborne Audio’s way of repurposing off-the-shelf Cat5 Networking cables to transport 4 channels of balanced analogue audio over a single cable. C.A.S.T. not only allows you to put input and output connectivity where you need it, but thanks to our clever impedance matching, the signal quality can exceed that of a mic cable for a fraction of the price and over a distance of up to 100m.

By utilising C.A.S.T. for audio transport rather than ethernet-based digital audio alternatives such as AES67, AVB, and Dante, we can provide a zero-latency, all-analogue audio transportation system that can be used to facilitate artist monitoring solutions as well as I/O relocation without sacrificing signal quality.

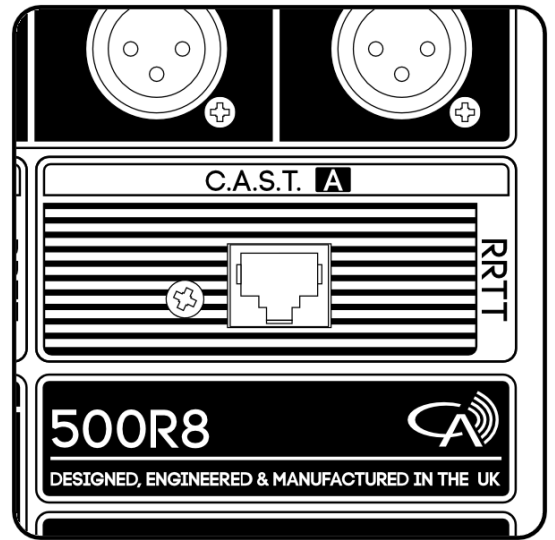

## C.A.S.T. IN A,B,C & D (RRTT)

The C.A.S.T. IN A, B, C, & D ports are designed to relocate the rear connections of 500R8 around the studio space and enable convenient access to 500R8’s I/O from remote locations. The four available paths are divided into two discrete mono receive paths as well as a stereo transmit path.

### Receive

Receives two mic/line sources from the connected C.A.S.T. breakout box and routes them directly into the inputs of 500R8’s 500 series slots when the Slot Source switches are set to “C.A.S.T.”

A detailed view of these C.A.S.T. assignments can be seen below:

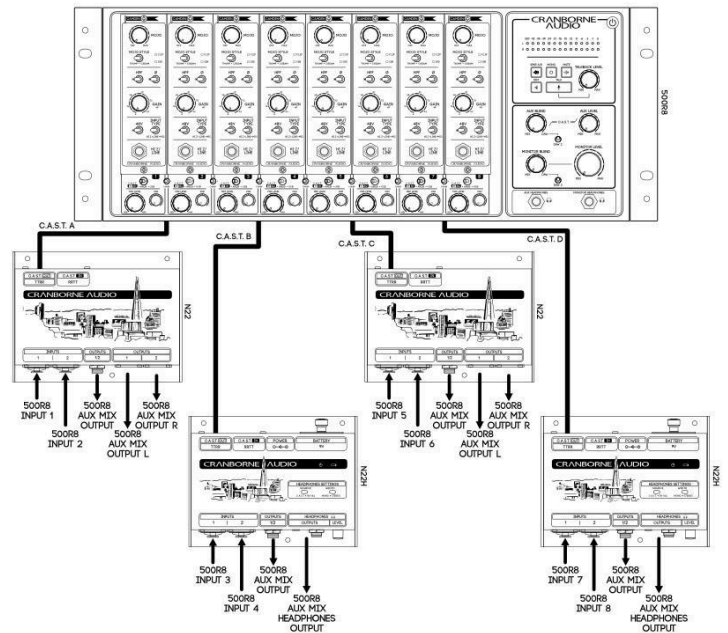

C.A.S.T. A		C.A.S.T. B		C.A.S.T. C		C.A.S.T. D	
C.A.S.T. A R1	C.A.S.T. A R2	C.A.S.T. B R1	C.A.S.T. B R2	C.A.S.T. C R1	C.A.S.T. C R2	C.A.S.T. D R1	C.A.S.T. D R2
SLOT 1	SLOT 2	SLOT 3	SLOT 4	SLOT 5	SLOT 6	SLOT 7	SLOT 8

## **Transmit**

Transmits the stereo Aux mix generated from 500R8 into C.A.S.T. and directly to the breakout boxes connected to 500R8 to enable monitor mixes to be distributed where they are needed around the studio space.

The stereo signal transmitted from 500R8 into the C.A.S.T. Transmit path is **Post** Aux Blend and **Pre** Aux Level control but also includes the Talkback signal generated on 500R8.

## C.A.S.T. Requirements

In order for C.A.S.T. to be as fool-proof as we wanted, we worked hard to make sure that the system would work perfectly using the standard and common off-the-shelf cat 5 cables without any loss of audio quality.

As a recommendation, we suggest using shielded Cat5 cables with robust connectors to ensure that the C.A.S.T. connection is secure and will remain impervious to RF and crosstalk.

For improved performance, you can consider Cat 6 or Cat 7 cabling which features individual shields for each twisted pair resulting in even greater crosstalk performance for very little extra financial investment.

### **Note:**

***C.A.S.T. is not a proprietary system, however any equipment that should support C.A.S.T. or similar in the future that has not had our involvement cannot be guaranteed to work to our exacting specifications and could suffer a loss in signal quality.***

# Cranborne Audio USB Control Panel

## Windows

If you are a Windows user, you will need to download 500R8's audio drivers and software control panel in order for the system to detect 500R8 and make it available as an audio device from within the Windows Sound Control Panel menu.

To download the latest Windows drivers for 500R8, please visit 500R8's product page on the Cranborne Audio Website.

Once the software package has downloaded, install the Windows driver by following the steps detailed in the software download.

Once the installation is complete, please follow the step by step guide in the "[Software Setup](#)" section of this manual to configure your operating system to use 500R8 as an audio device.

Once the Cranborne Audio USB Control Panel has been installed, it can be accessed directly using the taskbar on the bottom right of the Windows homepage display by double-clicking the Cranborne Audio logo.

The Cranborne Audio USB Control Panel adjusts several parameters of 500R8 to enable setup with complex systems and configuration for particular applications. We have worked hard to keep the panel as lightweight and simple as possible to reduce CPU load and improve latency performance where possible. There are 3 available tabs: Status, Settings, and Info.

### **Status**

The Status tab displays the connectivity status and ASIO settings of the connected 500R8.

The Connected indicator displays the current status of the connected 500R8. If 500R8 is discovered, the indicator will light Green and the ASIO section will display Latency and Sample Rate information. If the Connected indicator is grey and unlit, 500R8 is not currently being detected by the device.

The ASIO section displays the current Sample Rate and Latency information of 500R8 that is reported to the Control Panel directly from 500R8's USB driver. The latency figures will change depending on the current Buffer Size and Sample Rate selection.

### **Note:**

***The Sample Rate cannot be selected from within the control panel. Sample Rate is determined by the DAW project settings or the Windows 'Sound Control Panel' menu.***

## Settings

The Settings tab provides access to 500R8's Buffer Size and the Clock Source settings.

The Buffer Size drop down menu sets 500R8's Buffer Size for the desired use cases. When a DAW is opened, the Buffer Size is overridden and needs to be set from within your selected DAW's audio preferences.

### **Note:**

**As 500R8 facilitates 0-latency analogue monitoring using its Summing Mixer, we recommend setting the Buffer Size between 512 - 1024 samples to reduce load on your system and prevent possible audio artefacts during recording.**

**500R8 can operate at low latency with low buffer sizes, however performance at lower buffer sizes will vary depending on the performance of the connected device.**

## Safe Mode

Disables the output safety buffer for even lower output latency performance.

### **Note:**

**We recommend disabling Safe Mode only if the host device has sufficient CPU capacity to operate without pops, clicks, and other audio artefacts.**

The Clock Source drop down sets 500R8's current Clock Source. The Locked indicator displays the current status of the clock and will light Green when it is connected and synced or Red if dropouts are detected.

## Info

The Info tab displays the currently installed software and firmware for both the USB Control Panel and the connected 500R8. To guarantee best performance, please ensure that both software and firmware are kept up to date by signing up to Cranborne Audio's email newsletter for software announcements and checking the website regularly.

## macOS

As 500R8 is Core Audio compliant, it will connect directly with your Apple device and be instantly recognised as an audio device from within the "Audio MIDI Setup" application.

To configure 500R8 with macOS, please follow the step by step guide in the "[Software Setup](#)" section of this manual to configure your operating system to use 500R8 as an audio device.

# Application Guides

## Using 500R8 without 500 series modules

If you are new to the 500 series format and have yet to purchase any 500 series modules, you can still utilise all possible recording channels on 500R8.

Each 500 series slot features a dedicated Slot Bypass switch located beside the backplane connector which can be used to bypass the slot if no 500 series modules are inserted. Bypassing the slot allows you to connect line-level sources into the module inputs and send those signals onwards to your DAW via 500R8's USB Audio interface. For example, if you bypass slots 4-8, you can still connect line-level sources such as keyboards, the output of a mixing console, or an external preamp into the XLR sockets of each module. Even if a slot is bypassed, the Input XLR, Insert, Module Direct Output, and Mix Level/Pan controls are still active and can be used as normal.

The Slot Bypass switch is positioned after the Source switches on the front panel. If you switch the Source switch to USB, you are then able to send audio out from your DAW and into the 500 series slot, apply outboard processing using the module insert points, and then record the output into your DAW via USB without any 500 series module inserted.

Simply switch the Slot Bypass switch to the left and into its 'Bypassed' position and then you are good to go!

### **Note:**

**Remember to disable the 'Slot Bypass' switch when you wish to install a module into the 500 series slot! If you forget, the module will receive input signal from our selected source, but you will not hear the output of the module in the summing mixer or elsewhere through the signal path.**

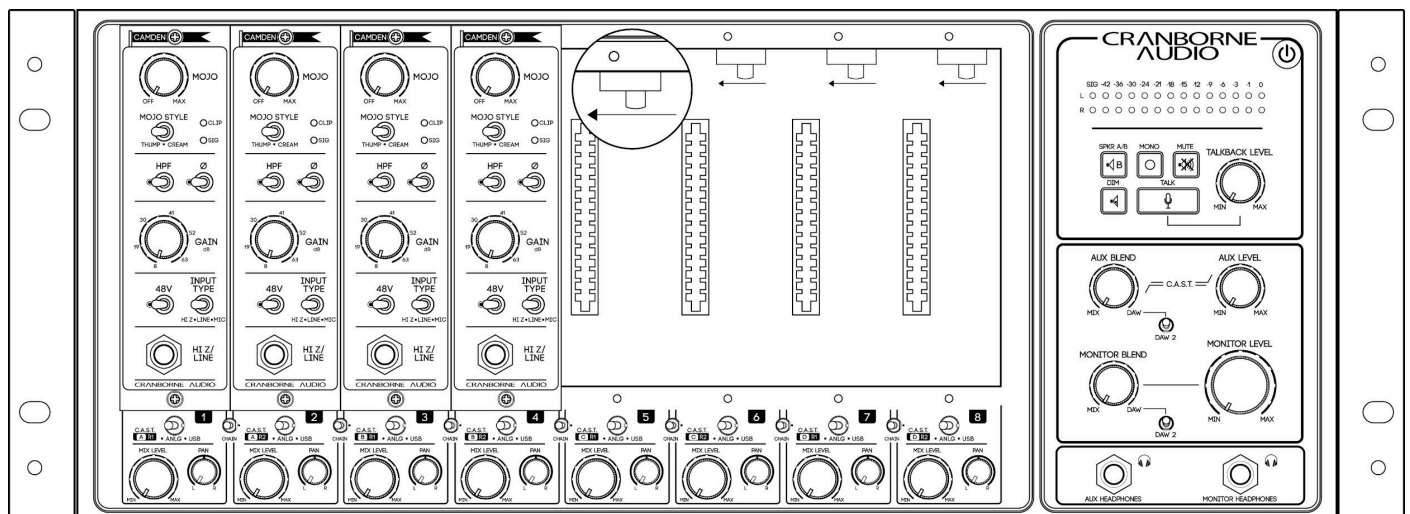

## Sending Audio From Your DAW, into the 500 Series modules on 500R8

The advantage of combining a 500 series rack and USB audio interface is that applying analogue hardware via USB is now easier than ever. Any 500 series module in 500R8 can receive its input via an incoming USB channel at the flick of a switch.

As an example, let's pretend we have a bus compressor in 500 series slots 7 & 8 of 500R8 that we want to apply across a stereo mix within the DAW.

1. In the DAW, set the output of the stereo audio track to USB Outputs 9 & 10 of 500R8.
2. On 500R8, set the Module Source switches beneath 500 series slots 7 & 8 to their 'USB' option.
3. Set the Pan controls of 500 series slots 7 & 8 to Left & Right respectively and raise both of their level controls to 12 O'clock.
4. Turn the Monitor Blend control of 500R8 to its 'Mix' position.
5. Press play in your DAW and adjust the Monitor Level control so that you can clearly hear the audio passing through the compressor inserted into 500 series slots 7 & 8.
6. With the stereo track playing, adjust the compressor settings to taste!
7. Create a new stereo track in your DAW and set its input to receive USB Inputs 9 & 10.
  - Set the output level of the compressor just low enough to avoid clipping on the tracks' input meters to get the maximum level before clipping.
8. Now rewind the cursor to the beginning of your stereo track, record-arm the newly created audio track, and hit the master record
9. You should see the waveforms begin to form on the audio track - this new audio file will feature your bus compressor settings applied!

You can follow this process one-track-at-a-time, or you can apply the analogue processing across multiple mono/stereo audio files at once.

## Using 500R8 With Hardware Inserts In your DAW

Many DAW's feature their own facilities that allow inserting analogue hardware directly into a channel strip within your DAW - much like a standard plug-in! If your DAW supports this, then you can simply Insert 500R8's 500 series slots as plug-ins on your desired audio track and set the Send and Return options of the plug in to correspond with your desired 500 series slots.

Each DAW handles this differently with some offering complete configuration of the Send/Return paths as well as automatic latency compensation.

We're going to cover this process in a few of the major DAWs, however please consult the user manual of your DAW to get the full instructions on how to insert analogue hardware across your audio tracks!

USB Send	USB Out 3	USB Out 4	USB Out 5	USB Out 6	USB Out 7	USB Out 8	USB Out 9	USB Out 10
500 Series Modules	<b>Module 1</b>	<b>Module 2</b>	<b>Module 3</b>	<b>Module 4</b>	<b>Module 5</b>	<b>Module 6</b>	<b>Module 7</b>	<b>Module 8</b>
USB Return	USB In 3	USB In 4	USB In 5	USB In 6	USB In 7	USB In 8	USB In 9	USB In 10

**Note:**

***Some dedicated 'hardware insert' plug-ins have an automatic calibration tool that can be used to determine the roundtrip latency and apply that time delay to the other DAW tracks to ensure that everything remains in phase and in time throughout your project and external hardware. If the DAW does not facilitate this, you may be able to enter the delay manually.***

### Hardware Inserts In Pro Tools

Using 500R8's 500 series slots as hardware inserts within Pro Tools couldn't be simpler. Pro Tools automatically assigns all of 500R8's I/O paths as numbered, hardware inserts meaning that all you need to do is 'insert' the hardware in the same way as you would a normal plug in.

To do this, simply:

1. Load up your Pro Tools project
2. Open the mixer page in Pro Tools
3. Select the track you wish to 'insert' your 500 series slot onto
4. Click on an insert space within the "inserts A-E" section of the channel strip
  - o (In the same way as you would load-up a standard plug-in)
5. Select "i/o" from the available list of plug in categories
6. Select an Insert from the available list.
  - o If the track is stereo, the Insert options will be in stereo pairs (Insert 1-2, 3-4 etc)
  - o If the track is mono, the insert options will be mono (Insert 1, 2, 3, etc)
7. On 500R8, make sure that the modules you wish to insert have their Module Source Select switch set to 'USB'.

Pro Tools automatically assigns the Send/Return points of each insert point with 500R8's USB interface. Pro Tools makes the assignments using like-for-like channels, meaning that the Send/Return paths for Insert 1 correspond with the input and output of 500 series slot 1.



Pro Tools does not currently allow for users to adjust the Send/Return point of each hardware plug in, however 500R8's channels have been strategically laid out to allow for every available slot/ADAT channel to be patched to within Pro Tools.

- 'Insert' 1-8 on Pro Tools corresponds with 500 series slots 1-8 on 500R8.
- 'Insert' 11-26 on Pro Tools corresponds with ADAT connections 1-16 on 500R8

### **Accounting for latency**

When using hardware inserts, you will need to take into account the latency that is added onto a track that is being routed through ADCs, DACs, and hardware inserts. Pro Tools allows for the user to manually compensate for the latency being added by the hardware insert - this can be found from within Setup, I/O..., H/W Insert Delay.

If you enter the amount of time (in ms) that it takes for the audio to pass through the hardware inserts, Pro Tools can then compensate by applying that time delay to all of the other tracks in the project - effectively shifting all of the other tracks so that they are 'in time' with the track passing through the hardware insert.

The issue with this concept is that there is no solid 'latency' figure that we can provide you. Latency varies entirely on the cpu power of your machine, the project size, the current buffer size, and the sample rate being used in the session. The actual round-trip latency figure will be different for every user.

The best way to proceed is to measure the roundtrip latency of your system using a 3rd party piece of software. A program we recommend is:

<https://oblique-audio.com/rtl-utility.php>

This software will measure the system and provide you with an accurate number to type into the H/W Sample Delay section in Pro Tools.

# Configuring Studio Monitors With 500R8

500R8's speaker outputs have been designed to provide the maximum dynamic range, headroom, and fidelity to offer the most accurate sound reproduction for mixing. Due to its high-output and wide-bandwidth design, you will need to configure your speakers' volume in order to get the most out of the monitor controller and its controls.

Due to this design, you may find that once 500R8 is connected to your speaker outputs, the Monitor Level control is extremely sensitive and very small movements can cause quite a change in volume. In order to get the most out of 500R8's monitor level control and configure your speakers to work best with 500R8, we recommend that you do the following:

1. Connect 500R8's Speaker A outputs to your desired studio monitors.
  - a. If they are powered monitors, you can connect the XLR's directly into the back of the speaker.
  - b. If they are passive monitors and require an amplifier, then you can connect the XLR's directly into the power amplifier.
2. Reduce the speaker/amplifier volume to its minimum setting.
3. Play source material/reference music out of 500R8's DAW returns and position the front panel monitor controls to the 12 o'clock position as detailed in the following diagram.
  - a. The LED meter should be showing a good level and flickering around -9 to -12dBFS.
4. With the music playing, slowly increase the volume of your studio monitors until you reach a volume that will be your 'loudest' setting when you are mixing.
  - a. It's important not to upset the neighbours during this task, however it is equally important to find a volume that is loud enough whilst remaining comfortable.
5. Once you have found a volume that works for you, reduce the Monitor Level control of 500R8's monitor controller to achieve your standard listening volume.

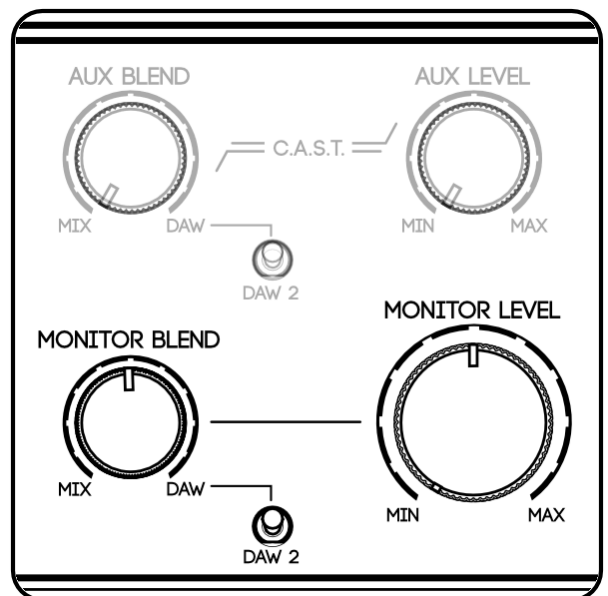

Now your speaker outputs and speakers themselves have been set up to allow for the greatest dynamic range whilst also giving you more control over the volume of your speakers using the monitor level control.

If you are using both Speaker A and Speaker B Outputs, then you can follow the same process for Speaker B.

# Creating Monitor Mixes For Musicians

Monitor mixes are an essential part of getting the best performance out of a musician. Ensuring that musicians can hear what they need to hear is one of the most important jobs of a recording session, but it can also be one of the most frustrating.

The majority of audio interfaces achieve monitor mixes by using convoluted software mixers that can achieve your desired task albeit with a lot of effort and time - time that you don't have during a recording session.

500R8 breaks down monitor mixing into two independent elements that are then blended together in the analogue domain using 500R8's Aux and Monitor Blend controls:

## **MIX**

The Mix would typically comprise live sources of the tracking musician(s). The analogue mix is created using the Mix Level and Pan controls beneath each 500 series slot.

## **DAW**

The DAW would comprise playback elements such as soft synths, click tracks, or audio backing tracks incoming from the DAW.

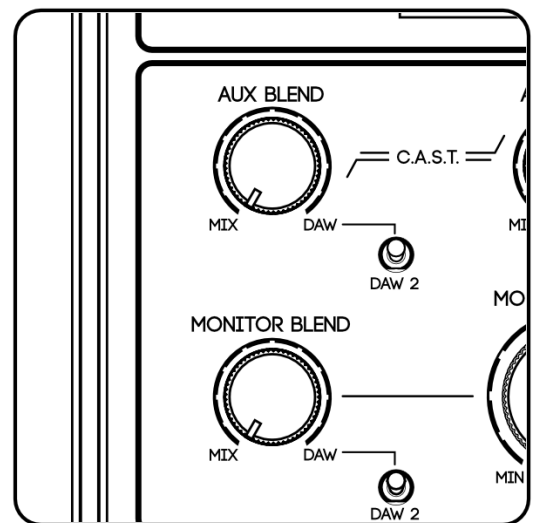

## Creating A Mix

Make sure that all of the instruments are connected to the inputs of 500R8, the input gains/levels of the modules are set correctly and Mix Level/Pan controls of each slot are set to minimum and center positions respectively.

1. Ensure both the Aux Blend controls are set fully anti-clockwise to the Mix position.
2. Connect a pair of headphones to the Aux Headphones port of 500R8 and hand them to the musician - make sure the Aux Level control is set conservatively at around 10/11 o'clock.
3. Press and hold the Talk key to communicate with the musician via talkback - raise the Talkback Level control until musician(s) can clearly hear the talkback bus.
4. Ask your musician(s) to start playing their instrument. They may not be able to hear their instrument at this stage.
5. Carefully begin adjusting each of the Mix Level and Pan controls below each 500 series module to create a mix of the live instruments. Throughout the process, carefully adjust the Aux Level control so that the musician can hear the mix clearly through the headphones - wait for the musician to ask rather than guess.

Focus on getting the important elements such as kick, snare and bass instruments prominent in the mix - musicians take their cues off of these important tracks. Communicate with the musician using the Talkback and ask them if they can hear all of the live instruments they need to hear at this stage. Make adjustments if needed.

At this point, you have a great sounding analogue monitor mix that balances all of the live instruments into the musician's headphones but you also need to send a click or scratch track into the Aux bus from your DAW session:

1. Begin playing your DAW session containing the desired backing track/click track
2. Slowly turn the Aux Blend control anti-clockwise until the musician can hear the desired balance between live and pre-recorded instruments.

500R8 allows for two completely independent blends of these two elements; one for the musician(s) (labeled Aux) and one for the engineer (labelled Monitor) each with their own dedicated headphones output.

## Using the DAW 2 Input

If the musician needs to hear a specific mix of pre-recorded instruments that differs from the monitor bus (such as the musician needs to hear the click track but the engineer does not) you can create another monitor Mix within your DAW including the click track and assign the output of that track to the DAW 2 output (USB output 29/30). In this eventuality, switch the DAW 2 switch over to the DAW 2 position

The beauty of using a blend control is that it is a very quick and easy way to flip between monitoring playback and live instrumentation. For example if a drummer wants to hear a recorded take, you can simply turn the blend control fully clockwise to the DAW position so that you can now hear the recorded take without having to continuously mute and unmute live channels.

## Adding Reverb Into The Monitor Mix

Reverb is a frequent component of monitor mixes in major, project, and home studios to help put a musician into a 'space' and provide a feeling that can inspire great performances. 500R8 allows you to insert a physical reverb of your choice into its monitor paths by using the DAW 2 ¼" inputs on the rear panel.

1. Connect the Mix Outputs of 500R8 into the input of your stereo reverb processor.
2. Connect the Output of your effects processor into the DAW 2 Inputs of 500R8.
3. Switch 500R8's front panel DAW selector to DAW 2.
4. Configure the mix of the reverb processor for 100% wet (sometimes called 'kill dry') and increase the output level to taste.
5. Blend in the reverb amount by using the Aux Blend control to balance between the dry mix (anticlockwise) or the wet reverb (clockwise).

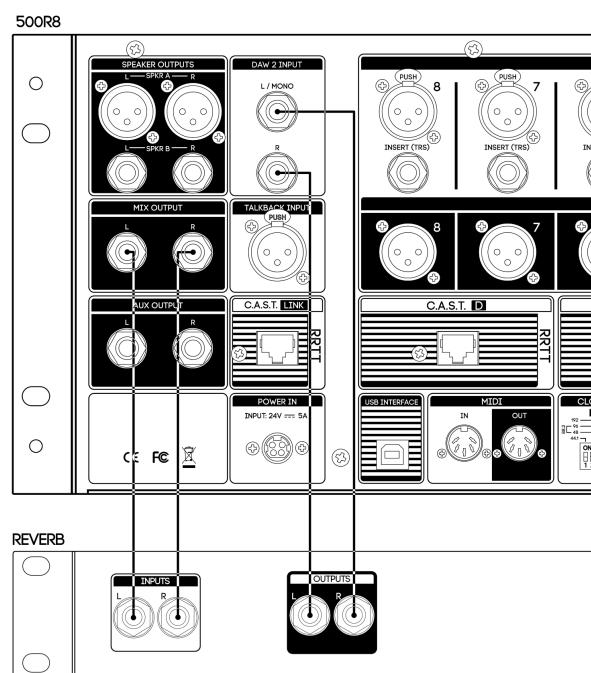

In this above setup, the reverb is applied across all contributions into the mix bus however you can apply specific reverb effects for certain instruments in isolation by sending the Module Direct Output of your desired channel into the reverb processor and connecting the reverb output into the DAW 2 Input returns.

## Expanding Your Recording System Using ADAT

Sometimes you need more inputs! As instrumentation grows, so does the need to capture every last possible source during the recording phase.

When more than 8 channels of recording is required, you can use 500R8's ADAT ports to expand its channel count to up to 24 channels by using any 3rd party ADAT device or the Cranborne Audio 500ADAT.

The total number of expansion channels will vary depending on your desired recording sample rate. If you want to record at 44.1/48kHz, you can add 16 extra channels onto the recording system by using 2 ADAT expanders simultaneously. If you want to record at 192kHz, you can add up to 4 channels onto the system.

The steps below cover the procedures required to expand your system by 8 channels at 44.1 or 48kHz sample rates.

1. Connect the ADAT OUT port of the ADAT expander to the ADAT IN 1 port of 500R8.
2. Connect the ADAT IN port of the ADAT expander to the ADAT OUT 1 port of 500R8.
3. Configure the ADAT expander to clock from the ADAT stream.
  - If the device does not support this operation, you can clock the unit via word clock by connecting the Word Clock Output of 500R8 to the Word Clock Input of the ADAT expander.
4. Select the current sample rate of the expander to match 500R8's operating sample rate.
  - If you frequently change between sample rates such as 48kHz and 96kHz between your DAW sessions, you will need to change the ADAT expander manually each time.

From this point, you can open up your DAW and record ADAT sources directly into your DAW by assigning the track inputs to receive ADAT Inputs 1-16.

# Using 500R8 and 500ADAT Together

500R8 and 500ADAT have been designed with two purposes in mind. 500R8 is for those looking to build a new or portable studio setup around the 500 series format, whilst 500ADAT is for those who are looking to add 500 series connectivity onto their existing studio setup and audio interface. But 500R8 and 500ADAT have also been designed to form a symbiotic relationship when being used together to enable larger recording channel counts and more options during the mix phase.

500ADAT adds a lot more functionality to 500R8 than just increased channel count using ADAT. Both 500ADAT and 500R8's Summing Mixers can be linked, their Aux Mixes can be merged, Talkback is cleverly managed between the two units, and there are some advanced routing capabilities that allow more monitoring facilities.

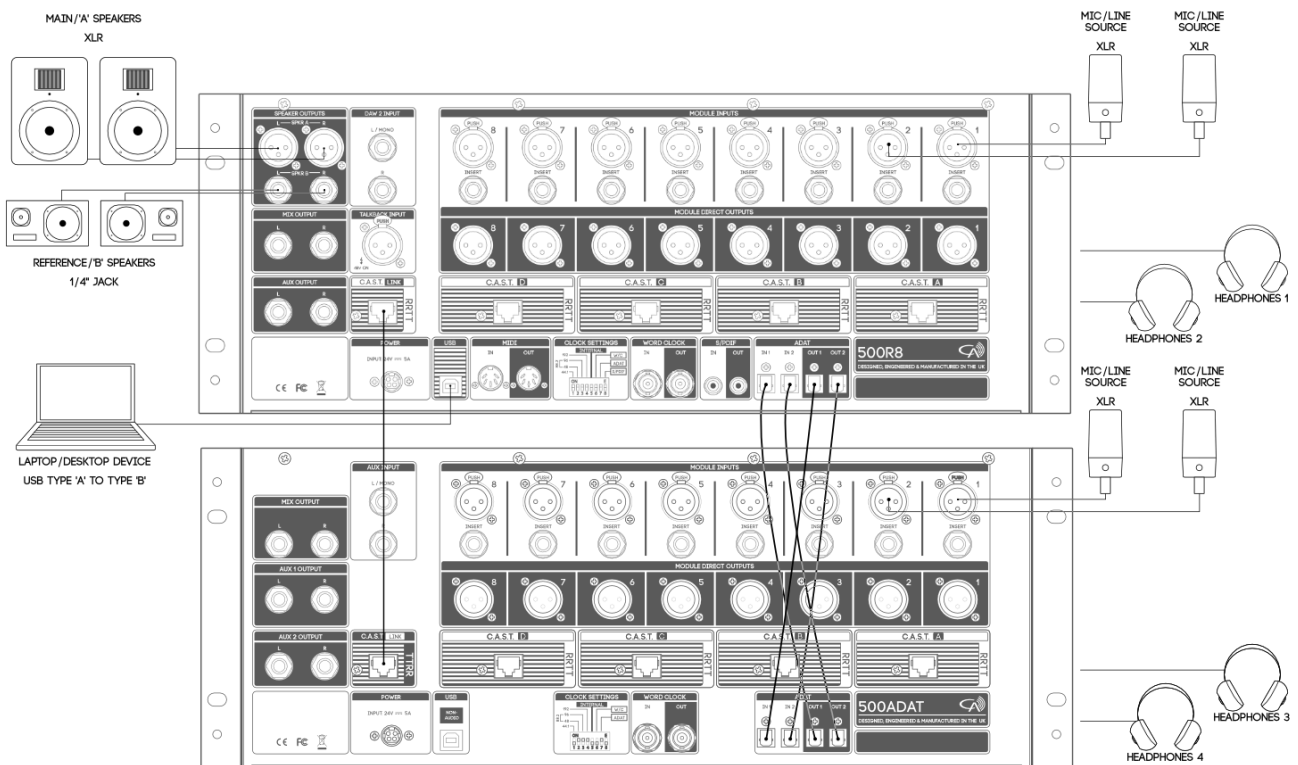

Each unit features 2 ADAT IN and 2 ADAT OUT ports that can be used to achieve 8 channels of expansion from 44.1kHz to 96kHz. When the two units are connected, you are able to patch to and from 500ADAT by using the ADAT I/O from within your DAW I/O routing.

### Inputs

The ADAT Inputs correspond with the 500 series slots on the 500ADAT and enable you to record the output of 500ADAT's slots into your DAW as individual channels.

### Outputs

The ADAT Outputs correspond with the 500 series slots on 500ADAT and enable you to send audio out from your DAW and into the modules that occupy 500ADAT 500 series slots.

## C.A.S.T. LINK

It is possible to integrate a wide variety of analogue paths between 500R8 and 500ADAT by using their C.A.S.T. LINK ports.

### **Summing Mixer**

When C.A.S.T. LINK is connected between the two units, the output of 500ADAT's Summing Mixer are sent straight out of the C.A.S.T. LINK port and summed with 500R8's own Summing Mixer. This doubles the Summing Mixer contributions to 16 possible channels and enables the engineer to create a full 16 channel, stereo summing mix by using the Mix Level and Pan controls beneath the modules on the 500ADAT and 500R8. In this instance all 16 channels are summed and sent out of USB output 1/2 as well as the physical Mix Output of 500R8.

### **Artist Monitoring**

The Aux bus on 500R8 is also sent via the C.A.S.T. LINK port and directly into 500ADAT's Aux 1 and Aux 2 Blend controls. This enables musicians connected to 500ADAT to blend the 500R8's Aux mix (featuring the DAW returns, Summing Mixer, and Talkback signals) with 500ADAT's own summing mixer directly into their headphone outputs.

### **Talkback Integration**

When the Talkback facility is used on the 500R8, the talkback signal is sent through C.A.S.T. LINK and directly the headphone outputs of 500ADAT as well as any N22/N22H's connected to the system. This means that you can communicate with your musicians easily wherever they are situated in your studio.

# Using 500R8 In Combination With Your Own AD/DA Converters

500R8 offers enough I/O to facilitate deep integration with 3rd party converters as well as a multitude of outboard processors. Not only does each 500 series module feature its own dedicated balanced output that can be run into 3rd party audio interfaces, but even the monitoring facilities, talkback, analogue summing and artist mix options of 500R8 can be used to their fullest effect without utilising 500R8's internal USB audio interface.

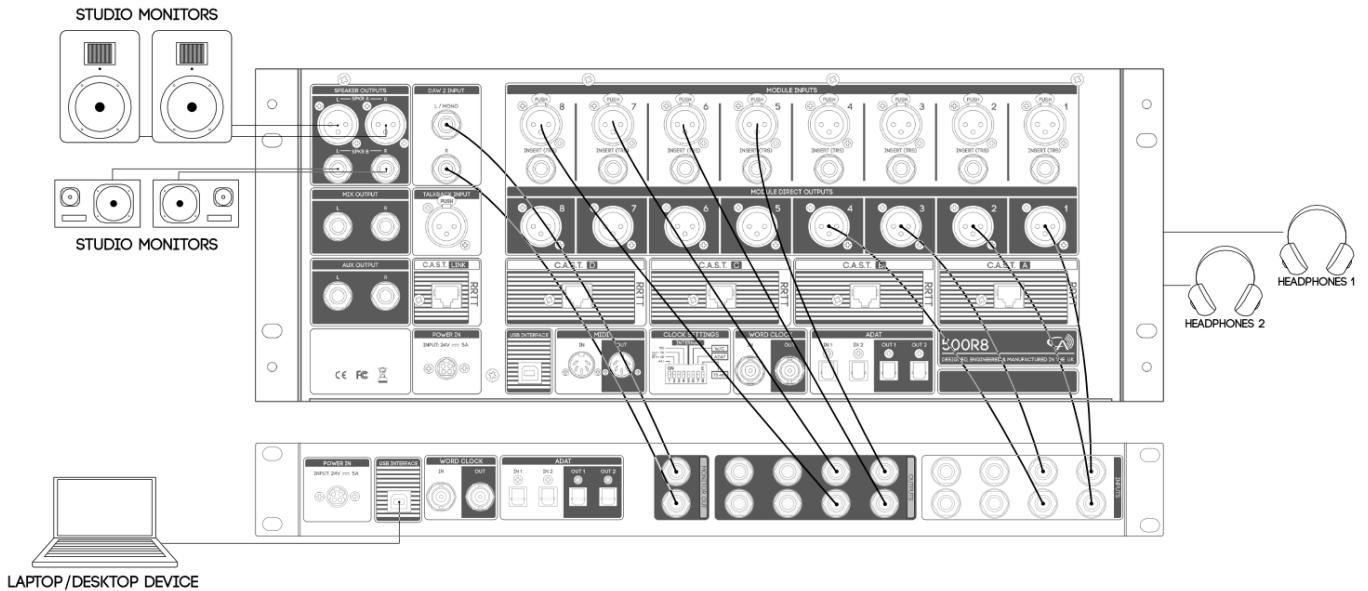

## Module Connections

Connect the 8 Module Direct Outputs of 500R8 into 8 spare inputs on your audio interface. This will allow you to send audio from 500R8's 500 series modules into the inputs of your audio interface for recording, monitoring, and processing. You can also connect the outputs of your audio interface into the module inputs of 500R8 to allow you to play sources from your interface and out into your 500 series modules installed into 500R8.

## Artist Mixer

Connect the Monitor Output of your audio interface into the DAW 2 Input jacks of 500R8 and switch the DAW Select switch on the front panel to the Daw 2 position. This will allow you to use the front panel blend controls to balance between the playback incoming via the DAW 2 Input and 500R8's internal Summing Mixer. Connecting 500R8 to an audio interface in this way enables the Monitor Controller, Blend Controls, and Headphone Outputs to function as normal.

## Summing Mixer

Connect the Mix Output of 500R8 into 2 spare inputs on your audio interface. This will allow you to send the summed, stereo mix of 500R8's internal Summing Mixer directly into the inputs of your external audio interface. Once connected, you can send audio from your audio interface into 500R8's modules to then be summed into a stereo track and sent back into your audio interface for recording.



# Understanding C.A.S.T.

As C.A.S.T. is all analogue, it cannot be reconfigured depending on what task is required by the end user. As such, it is important to recognise what C.A.S.T. port does what on the 500R8. To Aid in this process, Cranborne Audio's product and graphic design team has taken great care to add visual cues that will assist in their recognition.

Each of the 4 paths on all C.A.S.T. ports are labelled either T (Transmit), or R (Receive) depending on their function relating to the featured device. A socket that is labelled TTRR will transmit balanced audio over its first two paths (TT), and will receive balanced audio on its second two paths (RR). The box will also have a white header colour to display that it is an output.

Other C.A.S.T. ports labelled RRTT will receive balanced audio on its first two paths (RR) and will transmit balanced audio over its second two paths (TT). These boxes will have a clear header to display that it is an input. In addition to the path labelling, C.A.S.T. ports may also feature identification labels such as A, B,C, or D, or 'link' to provide further clarity as to their function or provide differentiation between several C.A.S.T. ports on the same product.

500R8 can integrate with a number of our C.A.S.T. enabled products. These products allow you to relocate the I/O where it's needed as well as headphone and monitoring capabilities for you musicians.

## N22

N22 is our simplest C.A.S.T. device and provides connectivity to C.A.S.T. A, B, C, or D ports onboard the 500R8. N22 features 2 combi jack inputs that feed directly into modules 'x' and 'x+1' on 500R8 as well as XLR outputs to receive the Aux bus generated from 500R8.

N22 can also be used as a standalone device by connecting 2 together using both C.A.S.T. In and Out ports. This will enable you to connect analogue I/O from one location into one N22 and run it to another N22 elsewhere in your studio/venue. N22 is completely passive and requires no power in order to be used.

## N22H

N22H is very similar to N22 in that it can be used passively to send audio into the modules of a connected 500R8. N22H however features a built-in headphone amp as well as a level control that receives the Aux bus of a connected 500R8 and amplifies it to the correct level and impedance for driving headphones.

N22H allows you to distribute input and headphone connectivity to and from a remote location using just a single Cat 5 cable. It is powered via a standard 'pedalboard-friendly' 9v DC power supply or via an internal 9v battery. Power is only drawn when the headphone output has been plugged-in to preserve battery life and when the headphone amp is not required, you can simply use the combi jack inputs as passive input connections.

When the C.A.S.T. port of N22H is not connected, it acts as a standard headphone amp by sending the two built-in inputs to L and R respectively of the headphone amp.

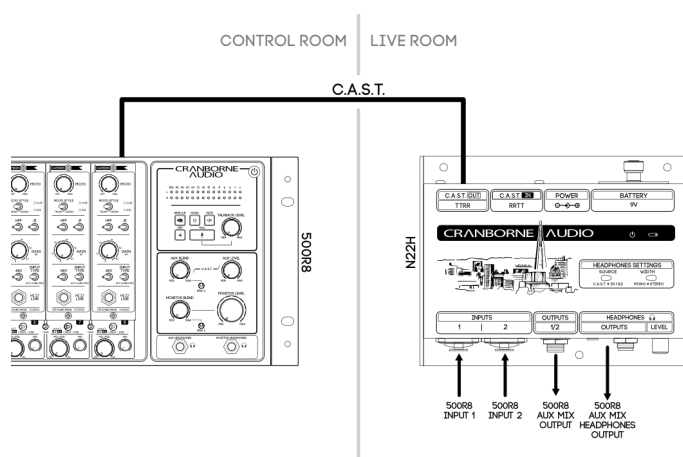

## Using N22 and N22H with 500R8

500R8 features 4 C.A.S.T. RRTT ports that enable cost effective and organised cable management around your studio by repurposing off-the-shelf Cat5/6/7 Networking cables to transport 4 channels of balanced analogue audio (mic, Line, or Instrument level) over a single cable.

Connect an N22 or N22H to one of 500R8's C.A.S.T. ports and you can place analogue I/O where you need it - whether it's in the live room, vocal booth, or the bedroom next door!

By connecting an N22H to the C.A.S.T. A port on the rear panel of 500R8, you can send a headphone mix out to the connected N22H whilst also receiving 2 inputs via N22H's combi connections. These inputs can then be directly fed into the front of modules 1 and 2 respectively by switching the Input source switch to C.A.S.T. A R1/R2 on slots 1 and 2.

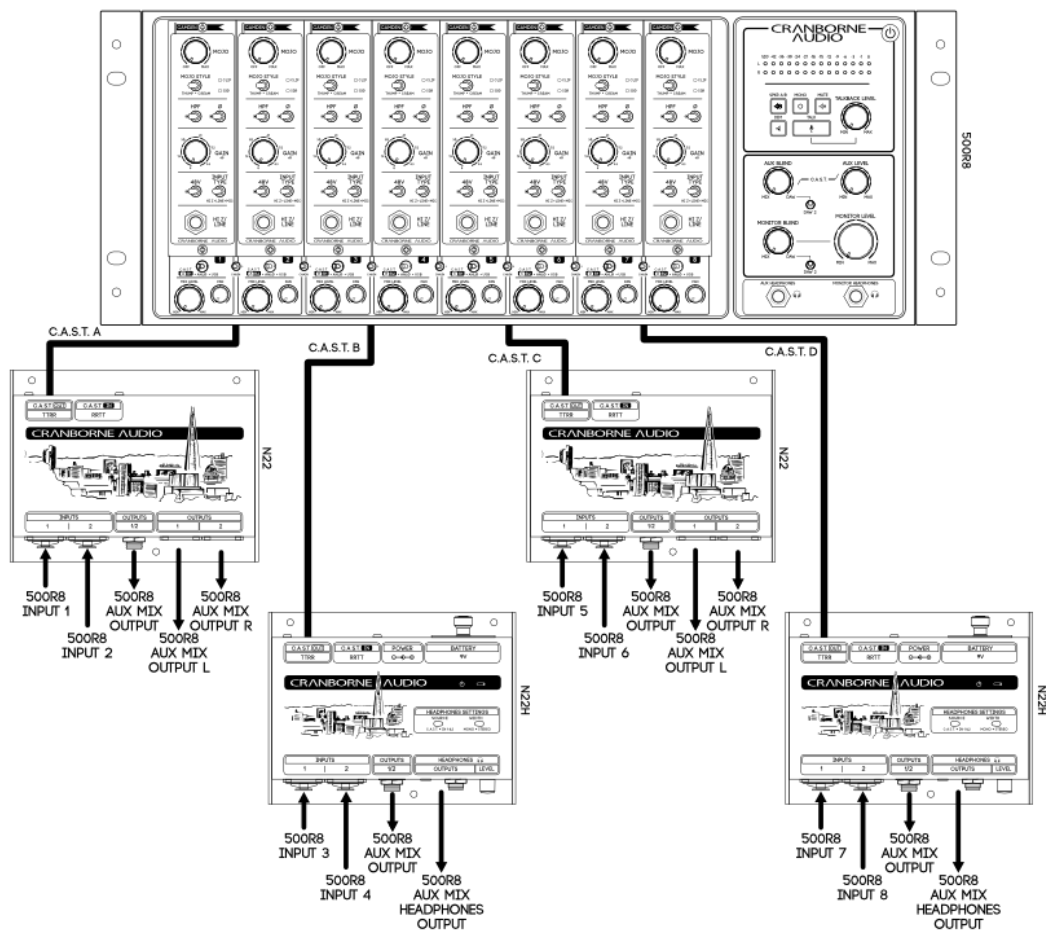

This is the perfect setup when a 'vocal booth' or 'isolation booth' is required as you can send the monitor mix to the vocalist whilst also receiving 2 analogue inputs by using just a single Cat 5 cable. Talkback is also managed by C.A.S.T. as 500R8 sends the talkback signal down C.A.S.T. to enable you to speak to the musician at the other end at the touch of a button. N22H can also be powered via a 9v battery which allows you to place the musician in any environment without power being a necessity.

By connecting up to 4 N22/N22H's to the back of a 500R8, you can create a completely plug and play, cost effective, all-analogue cabling distribution network that can be used to build up your studio and maximise your available space in the best possible way. Why not place the vocalist in the bathroom? Or the drums in the hall?

# USB Channel Labelling And Assignments

Here is the current USB channel count for 500R8 at each sample rate group.

## 44.1 - 48kHz

	<b>USB Input Label</b>	<b>USB Output Label</b>	<b>Assignment</b>
<b>1</b>	MIX L	DAW L	
<b>2</b>	MIX R	DAW R	
<b>3</b>	SLOT 1	SLOT 1	
<b>4</b>	SLOT 2	SLOT 2	
<b>5</b>	SLOT 3	SLOT 3	
<b>6</b>	SLOT 4	SLOT 4	
<b>7</b>	SLOT 5	SLOT 5	
<b>8</b>	SLOT 6	SLOT 6	
<b>9</b>	SLOT 7	SLOT 7	
<b>10</b>	SLOT 8	SLOT 8	
<b>11</b>	IN 11	OUT 11	<i>ADAT 1</i>
<b>12</b>	IN 12	OUT 12	<i>ADAT 2</i>
<b>13</b>	IN 13	OUT 13	<i>ADAT 3</i>
<b>14</b>	IN 14	OUT 14	<i>ADAT 4</i>
<b>15</b>	IN 15	OUT 15	<i>ADAT 5</i>
<b>16</b>	IN 16	OUT 16	<i>ADAT 6</i>
<b>17</b>	IN 17	OUT 17	<i>ADAT 7</i>
<b>18</b>	IN 18	OUT 18	<i>ADAT 8</i>
<b>19</b>	IN 19	OUT 19	<i>ADAT 9</i>
<b>20</b>	IN 20	OUT 20	<i>ADAT 10</i>
<b>21</b>	IN 21	OUT 21	<i>ADAT 11</i>
<b>22</b>	IN 22	OUT 22	<i>ADAT 12</i>
<b>23</b>	IN 23	OUT 23	<i>ADAT 13</i>
<b>24</b>	IN 24	OUT 24	<i>ADAT 14</i>
<b>25</b>	IN 25	OUT 25	<i>ADAT 15</i>
<b>26</b>	IN 26	OUT 26	<i>ADAT 16</i>
<b>27</b>	IN 27	OUT 27	<i>S/PDIF L</i>
<b>28</b>	IN 28	OUT 28	<i>S/PDIF R</i>
<b>29</b>		OUT 29	<i>DAW 2 L</i>
<b>30</b>		OUT 30	<i>DAW 2 R</i>

## 88.2 - 96kHz

	<b>USB Input Label</b>	<b>USB Output Label</b>	<b>Assignment</b>
<b>1</b>	SLOT 1	SLOT 1	
<b>2</b>	SLOT 2	SLOT 2	
<b>3</b>	SLOT 3	SLOT 3	
<b>4</b>	SLOT 4	SLOT 4	
<b>5</b>	SLOT 5	SLOT 5	
<b>6</b>	SLOT 6	SLOT 6	
<b>7</b>	SLOT 7	SLOT 7	
<b>8</b>	SLOT 8	SLOT 8	
<b>9</b>	MIX L	DAW L	
<b>10</b>	MIX R	DAW R	
<b>11</b>	IN 13	OUT 13	<i>ADAT 1</i>
<b>12</b>	IN 14	OUT 14	<i>ADAT 2</i>
<b>13</b>	IN 15	OUT 15	<i>ADAT 3</i>
<b>14</b>	IN 16	OUT 16	<i>ADAT 4</i>
<b>15</b>	IN 17	OUT 17	<i>ADAT 5</i>
<b>16</b>	IN 18	OUT 18	<i>ADAT 6</i>
<b>17</b>	IN 19	OUT 19	<i>ADAT 7</i>
<b>18</b>	IN 20	OUT 20	<i>ADAT 8</i>

## 176.4 - 192kHz

	<b>USB Input Label</b>	<b>USB Output Label</b>	<b>Assignment</b>
<b>1</b>	SLOT 1	SLOT 1	
<b>2</b>	SLOT 2	SLOT 2	
<b>3</b>	SLOT 3	SLOT 3	
<b>4</b>	SLOT 4	SLOT 4	
<b>5</b>	SLOT 5	SLOT 5	
<b>6</b>	SLOT 6	SLOT 6	
<b>7</b>	SLOT 7	SLOT 7	
<b>8</b>	SLOT 8	SLOT 8	
<b>9</b>	MIX L	DAW L	
<b>10</b>	MIX R	DAW R	

# Technical Specifications

Here is the comprehensive set of 500R8's technical specifications. We try to keep our specifications as real-world measurements. Each test has been carried out in a particular way to replicate how each element of 500R8 would perform in day-to-day operation.

**All specifications are typical performance unless otherwise noted. All specifications are subject to change at any time. Tested with Audio Precision APx555 at 192 kHz internal sample rate and internal clock. HF response of digital measurements will vary depending on sample rate selected during recording.**

## Digital Performance

### A/D Conversion

<b>Test Signal Path</b>	XLR Input - 500 Series A/D Converter - APx555 (ASIO)
<b>Frequency Response</b>	-1dB, 2.2Hz to >80kHz -0.05dB, 20Hz to 20kHz
<b>THD+N</b>	<0.00032% (-110dB) @ -4dBFS, 20Hz - 40kHz, 1kHz, A-weighted <0.00065% (-104dB) @ -1dBFS, 20Hz - 40kHz, 1kHz, A-weighted
<b>THD</b>	<0.00014% (-117.5dB) @ -8dBFS, 20Hz - 40kHz, 1kHz, A-weighted <0.00023% (-113dB) @ -4dBFS, 20Hz - 40kHz, 1kHz, A-weighted <0.0006% (-105dB) @ -1dBFS, 20Hz - 40kHz, 1kHz, A-weighted
<b>Dynamic Range</b>	121dB A-weighted, AES17 method, 20Hz - 20kHz
<b>Max Input Level</b>	+24dBu

### D/A Conversion

<b>Test Signal Path</b>	500 Series D/A Converter - Insert Send - APx555 (ASIO)
<b>Frequency Response</b>	-1dB, <1Hz to >61kHz -0.05dB, 20Hz to 20kHz
<b>THD+N</b>	<0.0003% (-110.5dB) @ -4dBFS, 20Hz - 40kHz, 1kHz, A-weighted <0.0004% (-108dB) @ -1dBFS, 20Hz - 40kHz, 1kHz, A-weighted
<b>THD</b>	<0.00014% (-117.5dB) @ -8dBFS, 20Hz - 40kHz, 1kHz, A-weighted <0.00018% (-115dB) @ -4dBFS, 20Hz - 40kHz, 1kHz, A-weighted <0.00036% (-109dB) @ -1dBFS, 20Hz - 40kHz, 1kHz, A-weighted
<b>Dynamic Range</b>	121dB A-weighted, AES17 method, 20Hz - 20kHz
<b>Max Output Level</b>	+24dBu

### Clocking

<b>Jitter</b>	<0.5ps
---------------	--------

Analogue Performance	
<b>Line Outputs (Speaker B, Aux, Mix)</b>	
<b>Test Signal Path</b>	DAW 2 D/A Converter - Line Outputs - APx555 (Line In)
<b>Connection Type</b>	1/4" Jack, Impedance Balanced
<b>Output Impedance</b>	150ohm balanced, 75ohm unbalanced
<b>Max Output Level</b>	<+22dBu
<b>Freq Response</b>	-1dB, 1.4Hz to >80kHz
<b>THD+N</b>	<0.003% @ +18dBu, 1kHz
<b>Dynamic Range</b>	105dB A-weighted, AES17 method, 20Hz - 20kHz
<b>Noise Floor</b>	<-93dBu A-weighted, 20Hz - 20kHz, (Unity Gain)
<b>Speaker A Output</b>	
<b>Test Signal Path</b>	DAW 2 D/A Converter - Speaker A Line Output - APx555 (Line In)
<b>Connection Type</b>	XLR, Balanced, non-floating
<b>Output Impedance</b>	150ohm balanced, 75ohm unbalanced (pin 3 unconnected)
<b>Max Output Level</b>	<+26dBu
<b>Freq Response</b>	-1dB, <1Hz to 70kHz
<b>THD+N</b>	<0.0016% @ +24dBu, 1kHz
<b>Dynamic Range</b>	109dB A-weighted, AES17 method, 20Hz - 20kHz
<b>Noise Floor</b>	<-92.5dBu A-weighted, 20Hz - 20kHz, (Unity Gain)
<b>Talkback Input</b>	
<b>Gain</b>	30dB Fixed Gain Preamp, +20dB Analogue Trim
<b>Phantom Power</b>	Always On
<b>Summing Mixer</b>	
<b>Test Signal Path</b>	XLR Input - Summing Mixer Bus (Unity) - A/D Converter 1/2 - APx555 (ASIO)
<b>Freq Response</b>	-1dB, 2.25Hz to >80kHz
	-3dB, 1.2Hz
	-0.5dB, 3Hz
<b>THD+N</b>	<0.0007% @ +23dBu (-1dBFS), 1kHz
<b>THD</b>	<0.0003% @ +14dBu (-10dBFS), 1kHz
	<0.0004% @ +20dBu (-4dBFS), 1kHz
	<0.00055% @ +23dBu (-1dBFS), 1kHz
<b>Dynamic Range</b>	108dB A-weighted, AES17 method, 20Hz - 20kHz
<b>Noise Floor (A/D 9-10)</b>	-108dBFS A-weighted, 20Hz - 20kHz
<b>Max Contribution Level</b>	+28dBu
<b>Pan Law</b>	-4dB
<b>Noise Floor (Mix Output)</b>	-90dBu, A-weighted, No channels routed
	-89.5dBu, A-weighted, 1 channel routed (Unity)
	-84dBu, A-weighted, 8 channels routed (Unity)

Headphone Amp	
<b>Test Signal Path</b>	DAW 2 D/A Converter - Headphone Output - APx555 (Line In)
<b>Frequency Response</b>	-1dB, <1Hz to >70kHz
<b>THD</b>	<0.0006% (-104.4dB) @ 20dBu, 1kHz, A-weighted, 300ohm load
<b>THD+N</b>	<0.00085% (-101.4dB) @ 20dBu, 1kHz, A-weighted, 300ohm load
<b>Output Impedance</b>	0.33 Ohms
<b>Output Wattage</b>	250mW x 2 @ 600 ohms, 1kHz
	650mW x 2 @ 220 ohms, 1kHz
	1.21W x 2 @ 100 ohms, 1kHz
	500mW x 2 @ 32 ohms, 1kHz
<b>Dynamic Range</b>	114.5dB A-weighted, AES17 method, 20Hz - 20kHz, 300ohm load
<b>Noise Floor</b>	-93.5dBu A-weighted, 20Hz - 20kHz, 300ohm load

System Performance	
Analogue Path Phase Performance	
<b>Test Signal Path</b>	XLR Input - Empty 500 Series Slot - Summing Mixer Bus (unity) - Monitor Bus - Speaker A Output - APx555 (Line In)
<b>Phase</b>	<3.6° @ 20Hz, <22° @ 20kHz
<b>Test Signal Path</b>	XLR Input - Empty 500 Series Slot - Summing Mixer Bus (unity) - Mix Output - APx555 (Line In)
<b>Phase</b>	<1.5° @ 20Hz, <11° @ 20kHz
<b>Test Signal Path</b>	XLR Input - Camden 500 Preamp (Mic Mode, 6dB Gain) - Summing Mixer Bus (unity) - Speaker A Output - APx555 (Line In)
<b>Phase</b>	<3° @ 20Hz, <13.5° @ 20kHz (Preamp mic mode, 6dB Gain)
Digital Round-trip Performance	
<b>Test Condition</b>	500 Series D/A Converter - 500 Series A/D Converter - APx555 (ASIO)
<b>Dynamic Range</b>	118dB A-weighted, AES17 method, 20Hz - 20kHz
<b>THD+N</b>	<0.0004% (-108dB) @ -4dBFS, 20Hz - 40kHz, 1kHz, A-weighted

Power	
<b>AC Requirements</b>	100V – 240V AC, 50 – 60 Hz
<b>Total Power Consumption</b>	24v, 5A DC, 120w
<b>500 Series Slot Current</b>	250mA per rail
<b>Total Available 500 Series Slot Current</b>	2A

Environmental	
<b>Operating Temperature</b>	+1 to 30 degrees Celsius
<b>Storage Conditions</b>	-20 to 50 degrees Celsius
Dims/Weights	
Unit	
<b>Width</b>	481mm(19"), Rackmount
<b>Height</b>	185mm(7"), 4u
<b>Depth</b>	219m(8.6")
<b>Unit Weight</b>	7kg
Shipping Carton	
<b>Width</b>	550mm(21.7")
<b>Height</b>	280mm(11")
<b>Depth</b>	335m(13.2")
<b>Weight</b>	7.5kg

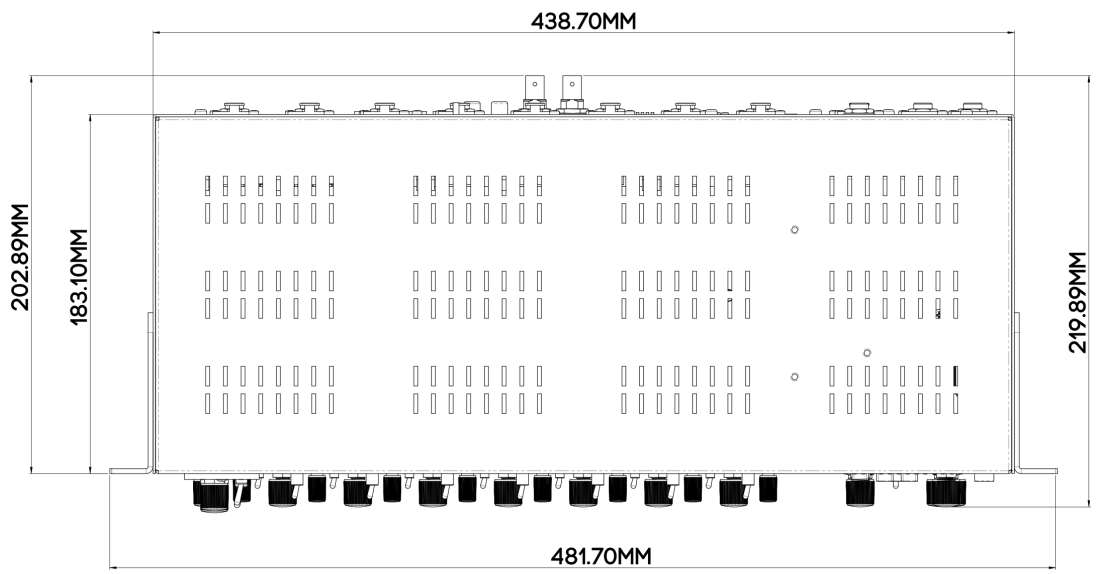

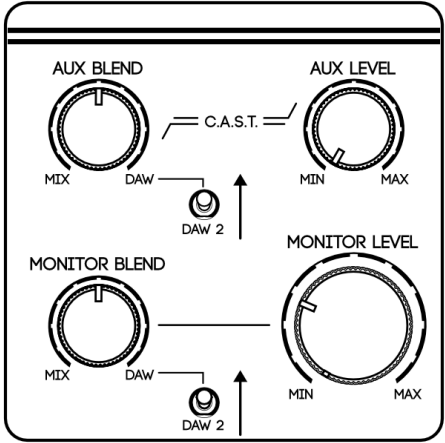

# Troubleshooting

Question	Solution(s)
<p>I can't hear any USB audio playback</p>	<ul style="list-style-type: none"> <li>• Ensure that 500R8 is connected, powered up, and selected as the default audio interface on your device's Sound Application/Control Panel.</li> <li>• Switch the DAW select switch into the UP position and turn the Monitor Blend control into the 12 o'clock position.</li> <li>• If you still can't hear USB audio playback, you need to check the output routing of the USB device from inside the control panel of your device.</li> </ul> <p><i>Please follow the steps detailed in the "<a href="#">Software Setup</a>" section of this manual.</i></p>
<p>My USB audio playback is playing through modules 1&amp;2</p>	<ul style="list-style-type: none"> <li>• Ensure that the output routing of 500R8 is set correctly from within the Sound/Control Panel of your device.</li> <li>• Ensure that the audio playback is configured to play out of USB output 1/2 on your device.</li> <li>• Ensure that the master section of 500R8 looks like the following diagram with DAW select switches in the UP position and Blend controls set to 50/50.</li> </ul> <p><i>Please follow the steps detailed in the "<a href="#">Software Setup</a>" section of this manual.</i></p> 
<p>The Monitor Control keymat is causing audible clicks through the speakers when changing function.</p>	<ul style="list-style-type: none"> <li>• The volume of your studio monitors is too high and reducing the dynamic range available from 500R8's Monitor Level control.</li> </ul> <p><i>Please follow the detailed guide to configure your studio monitors in the "<a href="#">Configuring Studio Monitors With 500R8</a>" section of this manual.</i></p>
<p>My DAW on macOS will not allow me to select a sample rate higher than 48kHz.</p>	<ul style="list-style-type: none"> <li>• In order to achieve a higher sample rate in your DAW using macOS, the desired sample rate needs to be selected from within the Audio MIDI Setup application on macOS.</li> </ul> <p><i>Please follow the detailed guide to configure your studio monitors in the "<a href="#">High Sample Rates On macOS</a>" section of this manual.</i></p>

# Important Safety Instructions

## General Safety

- Read these instructions carefully
- Keep these instructions
- Heed all warnings
- Follow all instructions
- Do not use this apparatus near water
- Clean only with a dry cloth
- Do not block any ventilation openings and install in accordance with the manufacturer's instructions.
- Do not install near any heat sources such as radiators, heat registers, stoves or other apparatus (including amplifiers) that produce heat.
- Do not defeat the safety purpose or grounding-type plug. A polarized plug has two blades with one wider than the other. A grounding type plug has two blades with a third grounding prong. The wide blade or the 3rd prong are provided for your safety. If the provided plug does not fit your outlet, consult an electrician for replacement of the obsolete outlet.
- Protect the power cord from being walked on or pinched particularly at plugs, convenience receptacles, and the point where they exit from the apparatus.
- Only use attachments/accessories recommended by the manufacturer.
- Unplug this apparatus during lightning storms or when unused for long periods of time.
- Refer all servicing to qualified service personnel. Servicing is required when the apparatus has been damaged in any way, such as power-supply cord or plug is damaged, liquid has been spilled or objects have fallen into the apparatus, the apparatus has been exposed to rain or moisture, does not operate normally, or has been dropped.
- Do NOT modify this unit, alterations may affect performance, safety and/or international compliance standards.
- Cranborne Audio does not accept liability for damage caused by maintenance, repair or modification by unauthorized personnel.

## Installation notes

- When installing the apparatus either fit it into a standard 19" rack or place it on a secure level surface.
- If the unit is rack mounted, fit all rack screws.
- When rack mounting, allow a 1U gap above and below the unit for cooling.
- Ensure that no strain is placed on any cables connected to this apparatus. Ensure that all such cables are not placed where they can be stepped on, pulled, or tripped over.



**WARNING: To reduce the risk of fire or electric shock, do not expose this apparatus to rain or moisture.**

**ATTENTION: Afin de réduire les risques de choc électrique, ne pas exposer cet appareil à l'humidité ou à la pluie.**

## Power Safety

- The unit is supplied with an external power supply and suitable mains lead. Only use the supplied external power supply, however if you decide to use a mains lead of your choice, bear in mind the following:
  - Refer to the rating label of the unit and always use a suitable mains cords.
  - The unit should ALWAYS be earthed with the earth on the IEC socket.
  - Please use compliant 60320 C13 TYPE SOCKET. When connecting to supply outlets ensure that appropriate sized conductors and plugs are used to suit local electrical requirements.
  - Maximum cord length should be 4.5m (15')
  - The cord should bear the approval mark of the country it is to be used.
- Connect only to an AC power source that contains a protective earthing (PE) conductor.
- Only connect unit to single phase supplies with the neutral conductor at earth potential.

**GB** The apparatus shall be connected to mains socket outlets with a protective earthing connection.

**DEN** Apparatets stikprop skal tilsluttes en stikkontakt med jord, som giver forbindelse til stikproppens jord.

**FIN** Laite on liitettävä sojamaadoituskoskettimilla varustettuun pistorasiaan.

**NOR** Apparatet må tilkoples jordet stikkontakt.

**SWE** Apparaten skall anslutas till jordat uttag.



**ATTENTION: Un-earthed metal parts may be present inside the enclosure. No user serviceable parts inside - to be serviced only by qualified personnel. When servicing, disconnect all power sources before removing any panels.**

## CE Certification



This unit is CE compliant. Note that any cables supplied with Cranborne Audio equipment may be fitted with ferrite rings at each end. This is to comply with the current regulations and these ferrites should not be removed.

## FCC Certification

- Do not modify this unit! This product, when installed as indicated in the instructions contained in the installation manual, meets FCC requirements.
- Important: this product satisfies FCC regulations when high quality shielded cables are used to connect with other equipment. Failure to use high quality shielded cables or to follow the installation instructions may cause magnetic interference appliances such as radios televisions and will void your FCC authorisation to use this product in the USA.
- This equipment has been tested and found to comply with the limits for a Class B digital device, pursuant to part 15 of FCC rules. These limits are designed to provide reasonable protection against harmful interference when the equipment is operated in a commercial environment. This equipment generates, uses, and can radiate radio frequency energy and if not installed and used in accordance with the instruction manual may cause harmful interference to radio communications. Operation of this equipment in a residential area is likely to cause harmful interference in which case the user will be required to correct the interference at their own expense.

## RoHS Notice

Cranborne Audio complies with and this product conforms to European Union's directive 2011/165/EU on Restrictions of Hazardous Substances (RoHS) as well as the following sections of California law which refer to RoHS, namely sections 25214.10, 25214.10.2, and 58012, Health and Safety Code Section 42475.2, Public Resources Code.

## Instructions for disposal of WEEE by end users in the European Union



The symbol shown here, which is on the product or on its packaging indicates that this product must not be disposed of with other waste. It is the user's responsibility to dispose of their waste equipment by handing it over to a designated collection point for recycling waste electrical equipment and electronic equipment. For more information about where you can drop off your waste equipment for recycling, please contact your local city office, your household waste disposal service or where you purchased the product.



**WARNING: cancer and reproductive harm - [www.P65Warnings.ca.gov](http://www.P65Warnings.ca.gov)**



Evaluation of apparatus based on altitude not exceeding 2000m. There may be some potential safety hazard if the apparatus is operated at altitude exceeding 2000m.



Evaluation of apparatus based on the temperate climate conditions only. There may be some potential safety hazard if the apparatus is operated in tropical climate conditions.

## Electromagnetic Compatibility

EN 55032:2015, Class B, EN 55016-2-1:2009 A1 2011, EN 55016-2-3:2010 A1 2010, EN 55035:2017, EN 61000-4-2:2009, EN 61000-4-3:2006 A1 2008 A2 2010, EN 61000-4-4:2012, EN 61000-4-5:2014 A1 2017, EN 61000-4-6:2014, EN 6100-4-11:2004 A1 2017, EN 61000-3-2:2014, EN 61000-3-2:2013, FCC Part 15B Class B, ANSI C63.4:2014, ICES-003 Issue 6: Class B

Audio input and output ports are screened cable ports and any connections to them should be made using braid-screened cable and metal conductor shells in order to provide a low impedance connection between the cable screen and the equipment.

**WARNING: Operation of this equipment in a residential environment could cause radio interference.**

### Environmental

- Operating Temperature: +1 to 30 degrees Celsius.
- Storage: -20 to 50 degrees Celsius.

**For more information and guidance, please read your devices' User Manual or visit the Cranborne Audio website:**

**[www.cranborne-audio.com](http://www.cranborne-audio.com)**