

OWNER'S MANUAL

LOPTROTTER
AUDIO ENGINEERING

MONSTER
COMPRESSOR

FET COMPRESSOR
with TUBE SATURATION

Table Of Contents

1. Introduction
2. Installation
3. Signal Path
4. Controls - Front Panel
5. Connectors - Rear Panel
6. Getting Started

Introduction

Thank you for choosing Looptrotter MONSTER. This two channel single band FET compressor provides unique functionality for individual instruments or sections (submixes for drums, guitars, keys). It can also be utilized on summing bus and in mastering.

MONSTER consists of three devices of an original design in one piece: FET compressor / limiter, tube saturator and fully transparent wet/dry signal mixer.

FET transistor is responsible for gain reduction and is optimized for adding low order harmonics. In its non-linear characteristics it reminds the electron tubes, so even with the deep compression the sound focused and detailed.

The saturation circuit is built with military grade electron tubes with a prolonged longevity (NOS). The unique feature of Monster Compressor is the option of boosting the even harmonics added by the tubes (2nd BOOST), especially useful for extreme processing of tracks and subgroups.

The MIX option is based on integrated circuits dedicated to sound processing. It is intended to sound transparent, but gives perfect functionality when using MONSTER as an insert device when 100% processing is unwanted.

Monster Compressor is a device with "analog character". It was designed to either complement super clean digital technology or expand sonic possibilities in your analog studio. The compression module treats the signal in a very musical way, before the tube saturation. And the unique combination of compression and tube saturation makes the sound seem distinctly closer, every detail stand out and gives the energy to the processed sound. It makes the sound more tactile and ear friendly.

MONSTER is a precise device, in terms of control and operation. All rotary switches (except saturation stage knob) are stepped, so it's easy to record and recall settings and allows you to maintain the same exact settings for both channels.

Installation

Looptrotter MONSTER is factory set to the correct mains voltage for your country. Please check the voltage setting on the rear panel.

With the power button switched off, connect the IEC mains cable to a 50/60 Hz AC source of the voltage typical for your country.

Connect the signals to the 3 pin XLR slots on the rear panel:

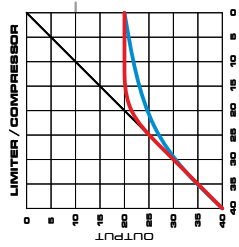
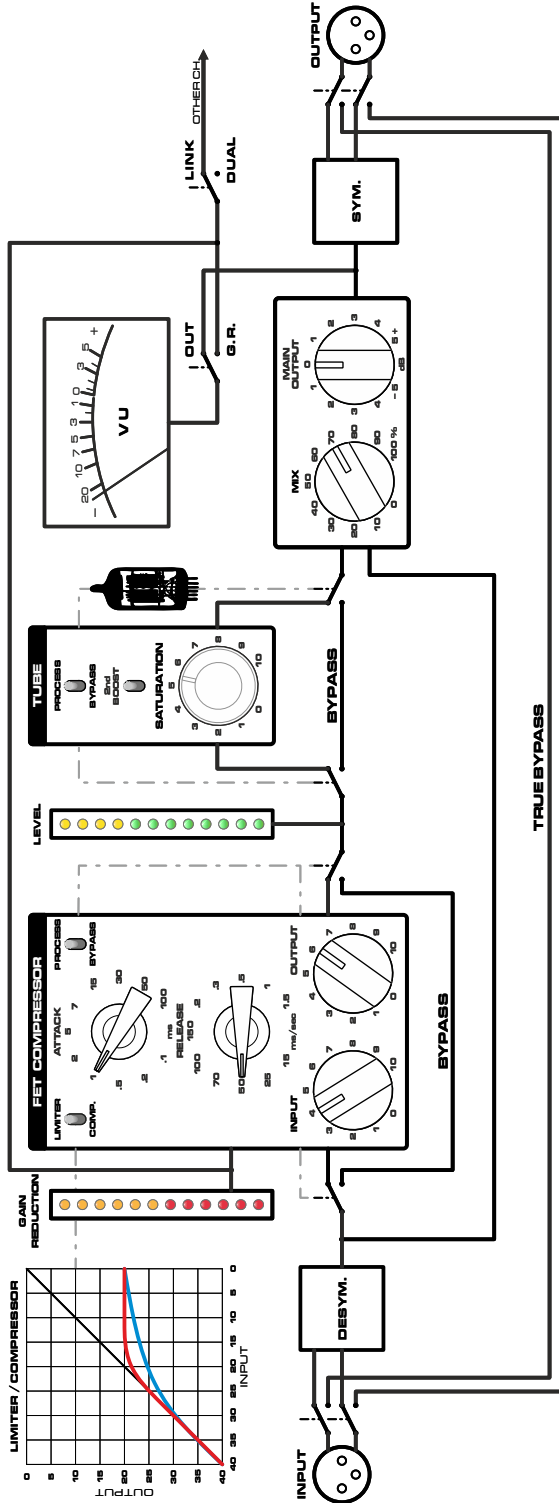

MONSTER COMPRESSOR

Signal Path

The FET Compressor Stage:

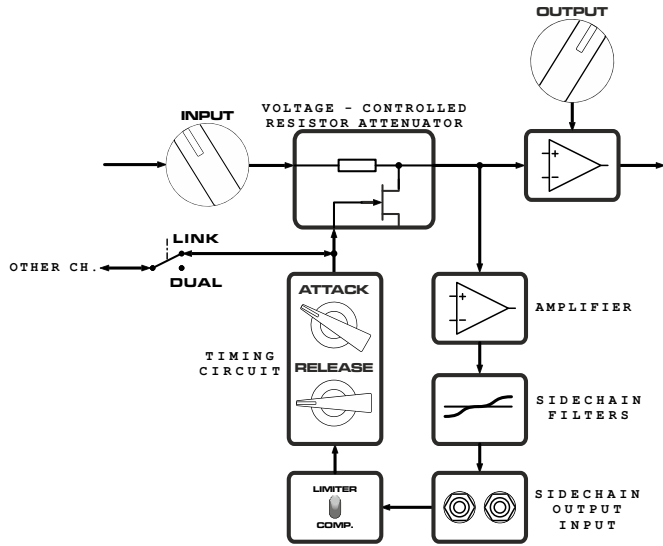
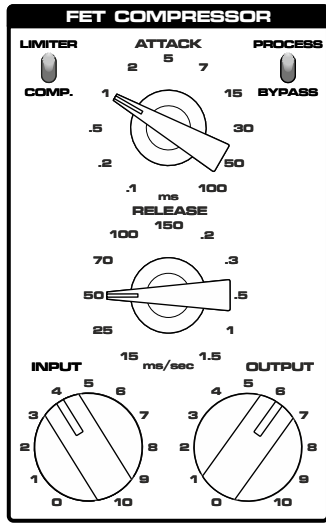

The FET compressor is fed by INPUT knob. There is no threshold or ratio setting, so the more signal gets into the compressor, the more gain reduction occurs. However, there are traditional attack / release setting knobs, allowing you to set fast to slow attack time (0.1 ms - 100 ms), and release time between 15ms to 1.5 sec. This is useful to shape the compressor's behavior and allows to use for example fast attack/release times for drums, and slower settings for vocals.

The compressor / limiter switch gives you the choice of compression curve. The compressor's curve has softer knee, while the limiter's knee is harder (see diagram)

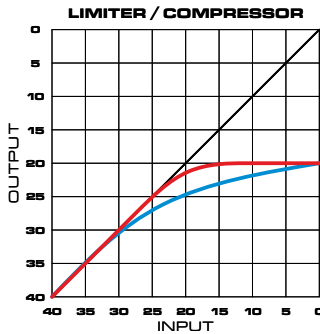

The bypass switch makes the signal avoid the compressor section completely. Output knob controls compressor's output level.

MONSTER COMPRESSOR

Tube Saturation stage:

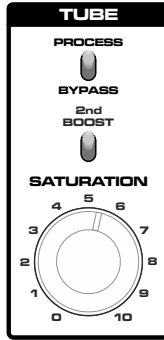

This is where the magic happens. The more signal gets into the tube saturation stage, the more saturation occurs. Please note that it also depends on the output level of the compressor's stage, so it gives you the option to get even more extreme saturation when raising the compressor's output level. The saturation knob indicates numbers from 0 (the smallest amount of saturation but still tube processing occurs!) to 10. To achieve more saturation, the 2nd BOOST switch brings up even harmonics introduced by the tube circuit. The process / bypass switch allows the signal to bypass tube circuit completely.

Mix and Output Stage:

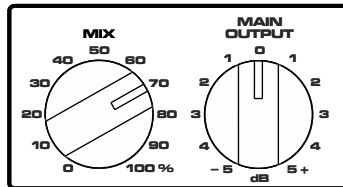

This section allows you to mix completely dry signal from the input of the device with processed signal (compressed and/or tube saturated) with the use of one mix knob. The numbers indicate the percentage amount of wet signal, so 0% means that on the output of MONSTER compressor is completely dry (unprocessed) signal, 50% means that there is equal amount of dry and processed signal, and 100% means that there is fully processed signal on the output of the device.

The Output knob allows you to tweak the output level of the MONSTER compressor. The range is from -5 to +5 dB.

MONSTER COMPRESSOR

Controls -Front Panel:

Beside the controls described in the section above there are few more elements in the central section of the front panel.

POWER -switches the device on or off

LINK/DUAL - when the **LINK** is **on**, the compressor's control voltage is summed up and common for both channels but all other settings for compressor's input, output, attack release, tube saturation knob and switches are independent. So if you want to use MONSTER compressor as the stereo unit you **MUST** set all knobs and switches to same exact settings.

When **DUAL** switch is on, both left and right channels of the compressor are fed by their own independent sidechain signal.

Ch 1/2 **PROCESS / TRUE BYPASS** - switches MONSTER's channels into fully operational circuit or completely bypasses the unit's circuits (the input signal is led directly to it's output)

Connectors - Rear Panel:

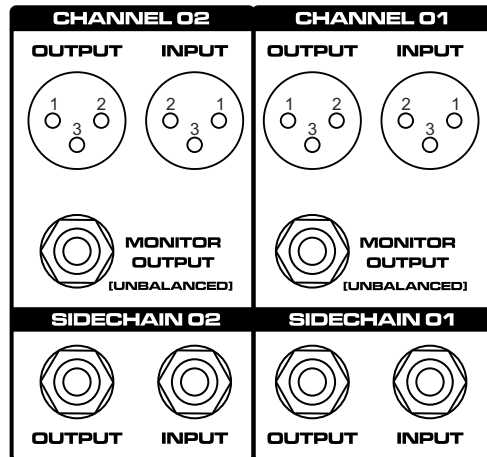

XLR:
PIN 1: ground
PIN 2: positive
PIN 3: negative

Channels 1 and 2 has input and output connectors based on XLR sockets. There are additional TRS unbalanced outputs for each channel marked as Monitor Output.

Sidechain Input and Output:

This circuit allows you to master-shape the compressor's sidechain signal. It can be used as an insert send/return to EQ the sidechain and obtain specific kind of compressor's behaviour, eg. boost of 8-10kHz on the external EQ and setting the compressor's attack/release to it's fastest settings will make the compressor act as a deesser.

Sidechain input can also be used to feed the compressor with external analogue signal, eg. using kick drum as the external sidechain signal while the compressor inserted on the main mix buss will make the compressor „pump-up“ the whole mix.

Getting Started:

As a starting point for general purpose, set compressor's input and output to 5, attack 15 and release to 50. Set mix knob to 100% and Main Output to 0. Increase compressor's input and listen how gain reduction works with your signal. When you decide your signal is well cooked, start decreasing the Mix amount and listen how processed signal blends with the dry signal. Try changing attack and release of the compressor. As soon as you're done with experimenting with the compressor itself, engage the tube saturation circuit and check how it works with the processing you've already achieved.

The most natural warmth and tube-style distortion can be obtained with Saturation at 4 and 2dBoost switch to off.

More overdrive may be obtained by switching the 2d Boost and turning the saturation knob over 6. Adding very fast attack and release time and switching compressor to limit mode gives more harshness from both compressor and tube saturator.

For optimum results make sure the source signal is not clipped before it arrives at the MONSTER's input.

MONSTER
COMPRESSOR

LOOPTROTTER
AUDIO ENGINEERING