

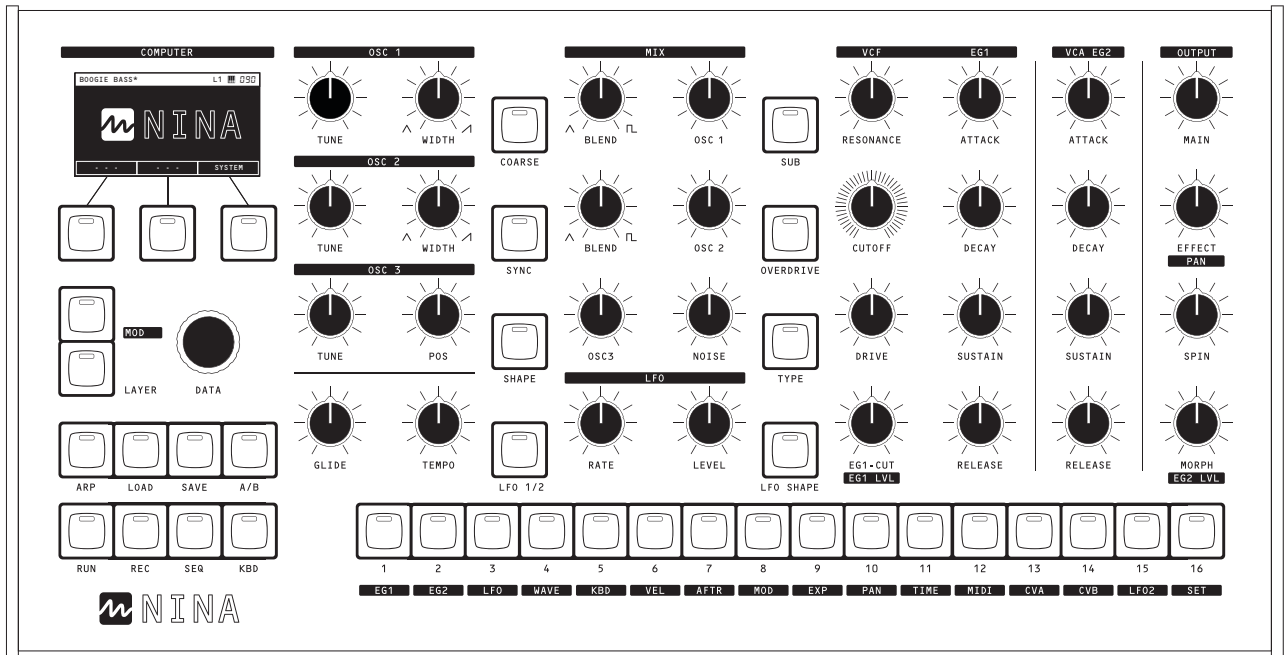

MELBOURNE  
INSTRUMENTS



# NINA

12 Voice Analog Polyphonic Synthesizer

## User Manual

---

## Contents

|   |    |   |    |
|---|----|---|----|
| <b>Introduction</b> .....                       | 3  | <b>Input Select</b> .....                     | 19 |
| <b>Safety &amp; Compliance Statements</b> ..... | 3  | Ex Input Gain .....                           | 19 |
| <b>Overview</b> .....                           | 4  | <b>Voice Mix</b> .....                        | 20 |
| <b>Voice Architecture</b> .....                 | 4  | <b>Drive &amp; Overdrive</b> .....            | 20 |
| <b>Unit Overview</b> .....                      | 6  | <b>Filter / VCF</b> .....                     | 20 |
| Main Control Panel .....                        | 6  | <b>Filter Envelope EG1</b> .....              | 21 |
| NINA Keys .....                                 | 8  | EG1-CUT .....                                 | 21 |
| NINA Knobs .....                                | 9  | VCA EG2 .....                                 | 22 |
| Rear Panel & Connections .....                  | 10 | <b>Glide / Portamento</b> .....               | 22 |
| <b>Display Layout</b> .....                     | 12 | <b>Stereo Infinite Panning</b> .....          | 23 |
| <b>Basic User Interface Principles</b> .....    | 12 | The Panner .....                              | 23 |
| Scopes - OSC / XY / Off .....                   | 13 | MOD Matrix Pan .....                          | 23 |
| <b>Presets</b> .....                            | 14 | Unison .....                                  | 24 |
| Loading Presets .....                           | 14 | Spin .....                                    | 24 |
| Initialize Preset .....                         | 14 | <b>Modulation</b> .....                       | 25 |
| Banks .....                                     | 14 | LFOs .....                                    | 25 |
| Rename .....                                    | 14 | EG1-CUT .....                                 | 26 |
| Saving Presets .....                            | 15 | MOD mode .....                                | 27 |
| Import & Export Presets .....                   | 15 | Modulation Sources .....                      | 28 |
| <b>Morphing and A/B Compare</b> .....           | 15 | Modulation Destinations .....                 | 29 |
| Dance Mode .....                                | 16 | <b>Layers / Multi-timbral Operation</b> ..... | 30 |
| DJ Mode .....                                   | 16 | Effects with Multi-Timbral .....              | 30 |
| Store to A/B .....                              | 17 | Arpeggiator with Multi-Timbral .....          | 30 |
| Load a Preset into B .....                      | 17 | Multi-Timbral Configuration .....             | 31 |
| <b>Patch Design</b> .....                       | 17 | Reset .....                                   | 31 |
| Nina Voice Block Diagram .....                  | 5  | Layer Navigation .....                        | 31 |
| Analog VCOs .....                               | 17 | Layer Voices .....                            | 31 |
| Digital Oscillator .....                        | 18 | Output Routing .....                          | 32 |
| <b>Noise and Other Sources</b> .....            | 19 | Low Note / High Note .....                    | 32 |
| XOR .....                                       | 19 | MIDI Channel .....                            | 32 |
| White .....                                     | 19 | MPE .....                                     | 32 |
| Pink .....                                      | 19 | Volume .....                                  | 33 |
| Aux In .....                                    | 19 | CV A and CV B Source .....                    | 33 |

## Melbourne Instruments Pty. Ltd.

331 Johnston St,  
Abbotsford VIC 3067  
Australia  
[melbourneinstruments.com](http://melbourneinstruments.com)

|  |    |  |    |
|--|----|--|----|
| <b>Patch/Presets Global Settings</b> .....   | 33 | <b>Bank/Presets Management</b> .....                   | 42 |
| Poly Mode.....                               | 33 | Import Bank .....                                      | 42 |
| Unison Voices and Unison Detune .....        | 33 | Export Bank.....                                       | 43 |
| Panner Voices and Panner Mode .....          | 33 | Add bank.....  | 43 |
| Pitch Bend Range.....                        | 33 | Clear Bank.....  | 43 |
| Time Mod Rate.....                           | 33 | <b>Wavetable Management</b> .....                      | 44 |
| <b>Loading and Saving Layer Setups</b> ..... | 34 | Import & Export.....                                   | 44 |
| Load .....                                   | 36 | Delete.....  | 45 |
| Save .....                                   | 36 | <b>About</b> .....                                     | 44 |
| <b>Arpeggiator</b> .....                     | 36 | <b>Firmware Upgrades</b> .....                         | 44 |
| Basic Operation.....                         | 36 | USB Flash Drive Removal.....                           | 44 |
| Dir Mode .....                               | 37 | <b>Appendix A: MIDI</b> .....                          | 45 |
| Hold.....                                    | 36 | <b>Appendix B: Wavetables</b> .....                    | 46 |
| Note Value.....                              | 36 | <b>Appendix C: Technical Specifications</b> .....      | 47 |
| External Sync.....                           | 36 | <b>Appendix D: Troubleshooting &amp; Support</b> ..... | 48 |
| <b>Sequencer</b> .....                       | 38 | <b>Warranty</b> .....                                  | 49 |
| Recording a Sequence.....                    | 38 | <b>User Notes</b> .....                                | 50 |
| Playing a Sequence.....                      | 38 |  |    |
| <b>KBD</b> .....                             | 38 |  |    |
| All Notes Off .....                          | 38 |  |    |
| <b>Effects</b> .....                         | 39 |  |    |
| Chorus .....                                 | 40 |  |    |
| Delay .....                                  | 40 |  |    |
| Reverb .....                                 | 40 |  |    |
| <b>System Functions</b> .....                | 41 |  |    |
| Global Settings .....                        | 41 |  |    |
| MIDI Clock In .....                          | 41 |  |    |
| MIDI Echo Filter.....                        | 41 |  |    |
| Master Tuning.....                           | 41 |  |    |
| CV Offset Gain and Mode .....                | 41 |  |    |
| Backup.....                                  | 41 |  |    |
| Restore.....                                 | 41 |  |    |

## Introduction

Welcome to NINA, the first synthesizer from Melbourne Instruments.

Nina is a modernised version of the classic analog synthesizer. It is our 12 Voice flagship, featuring a fully motorized control panel, virtually unrestricted and unlimited modulation matrix, multi-timbral operation and a modern computer architecture built on an open-source platform.

We are particularly pleased with the Morph function, the way Nina's motorised control panel makes it easy to set up the Mod matrix, the quality of the digital effects, and the haptics that give dynamic tactile feedback which is useful and fun.

Nina's patent pending motorized knobs are a world first in synthesizers. They have been custom designed from a 3 phase brushless drone motor design. They are an extremely robust, high reliability design that will practically never wear out. The position sensing is done using a contactless optical system with extremely high resolution and ultra-low noise.

The circuits are custom designed and do not use resistor trimpots (which can go out of calibration). Tuning is maintained by measuring the temperature characteristics of the transistors in a factory calibration step, and then high precision FPGA monitoring of the circuits to track their operating point with temperature while the unit is running.

## About the User Manual

This manual is a guide that assumes you already have a good understanding of how these kinds of classic analog and wavetable synthesizers are used to create sounds. It will explain all the newer features of Nina that build on this foundation.

## Safety & Compliance

**Tested to comply with FCC Standards FOR HOME OR OFFICE USE.**

This device complies with Part 15 of the FCC Rules. Operation is subject to the following two conditions:

- (1) This device may not cause harmful interference and
- (2) This device must accept any interference received, including interference that may cause undesired operation.

# Overview

## Motorized Control Panel

Nina's unique motorized control panel differentiates it from all other synthesizers. This new technology allows all the control surface knobs to automatically move to where they are supposed to be. During Patch editing, they show how the oscillators, VCF, VCA etc are set. In Modulation Mode, they show you how much each MOD destination is assigned. In Multi-Timbral, they jump between the different presets as you change the current layer, and in MORPH mode the entire control panel updates on the fly, according to the Morph amount.

An important aspect of the knobs is that they are very high resolution. They are higher resolution than traditional potentiometers, and are based on a contactless optical analog position sensor. The resolution of the sensor is extremely high, around 15,000 steps. This resolution is what actually controls the audio circuitry and what is stored in the Preset. The LCD display will show a rounded down version of this eg 0 to 100 in steps of 1, but that does not mean that the position is only defined by 100 steps.

The **DATA Knob** is used to interact with the LCD screen, and the 3 Keys under the LCD are **soft-keys**, with their functions labelled on the LCD. The remainder of the knobs have dedicated functions printed under them. The main output volume is the only standard potentiometer in the unit.

Nina's red keys each have an LED to indicate status. These are summarized in the table on page 8.

## Voice Architecture

The main stereo output analog signal is sampled by an internal 96kHz, 24bit ADC, and passed through stereo digital effects which are mixed back into the main analog outputs. The two AUX outputs (Outputs 3 + 4) are always sent out without effects.

See Block Diagram on page 5 and Layer Setups on page 34 for more information.

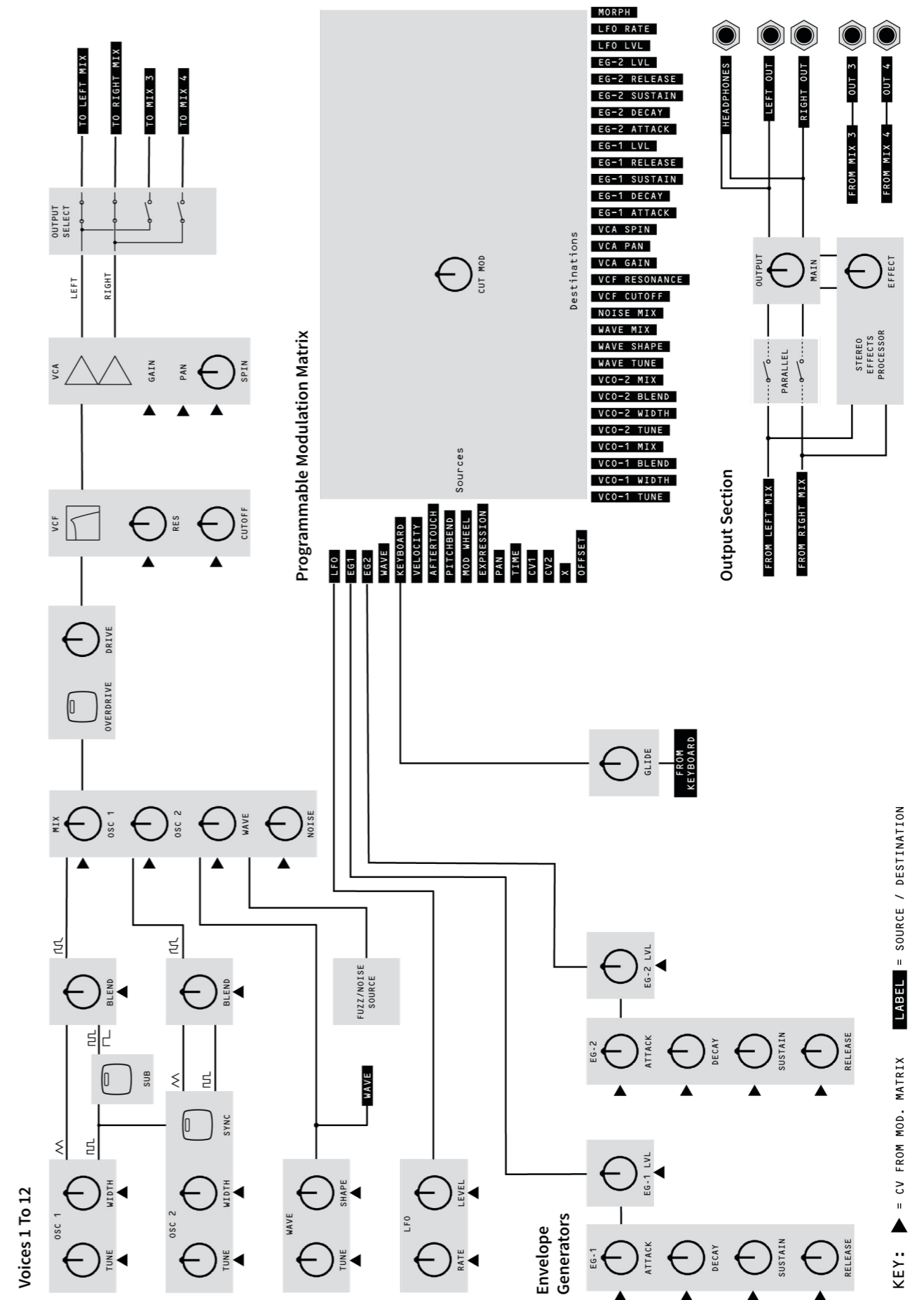

# Main Control Panel

See Pages 8-13 for detailed descriptions and basic operations.  
Refer also to the **Getting Started Guide** included with NINA.

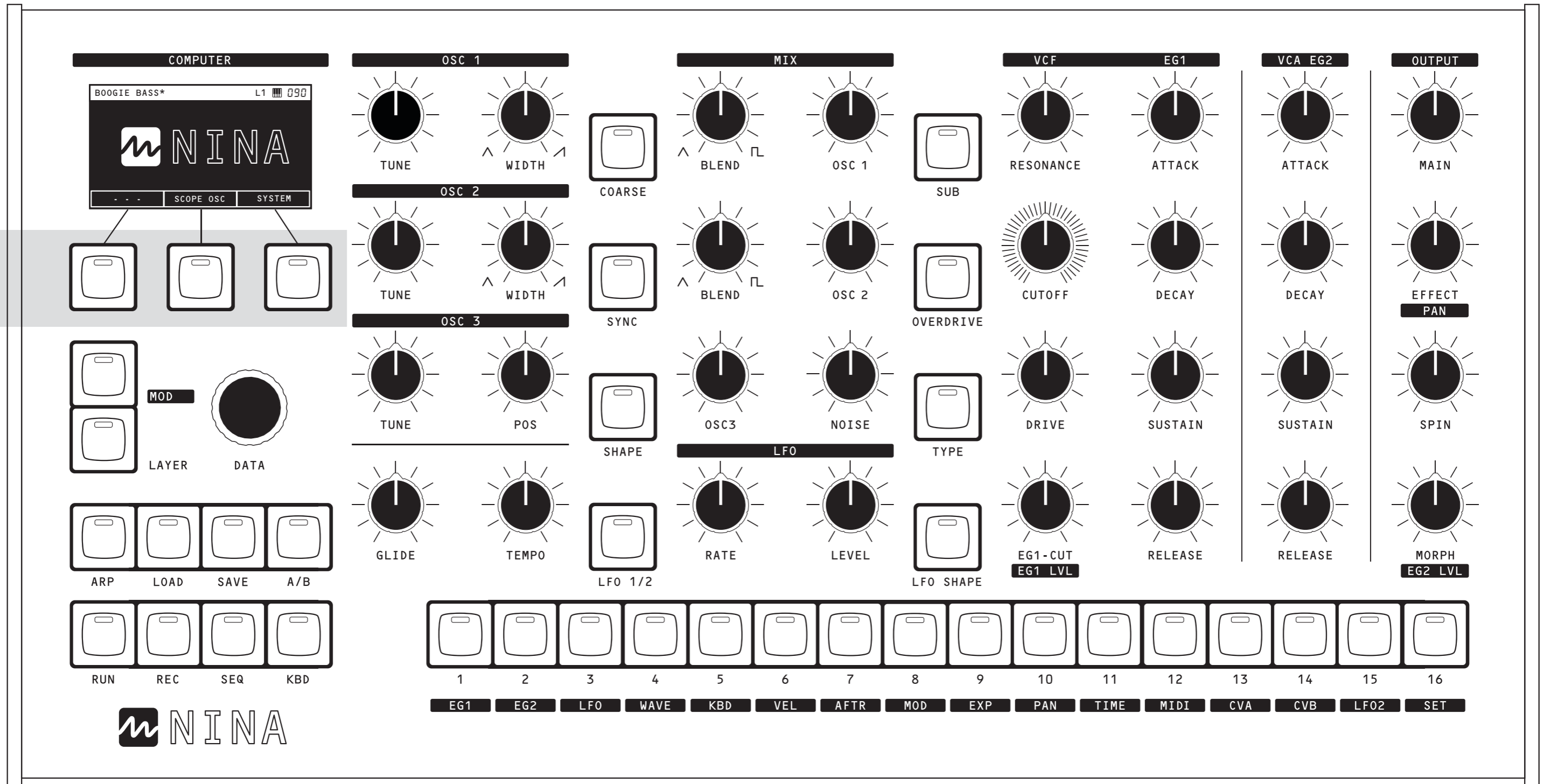

## NINA Keys

| KEY          | LED STATUS   | FUNCTION   |
|--------------|--|--|
| SOFT KEY 1   | ON = key pressed   | EXIT / BACK / BANK   |
| SOFT KEY 2   | ON = mode active   | EDIT / RENAME + SCOPE OSC / SCOPE XY / SCOPE OFF   |
| SOFT KEY 3   | ON = key pressed   | SYSTEM / ENTER / SAVE / LOAD / RESET / STORE TO / OK   |
| MOD          | Blinking = MOD mode active   | Enter modulation mode  |
| LAYER        | ON = Layer Menu active   | Multi-timbral setup and global Preset parameters.  |
| ARP          | ON = Arpeggiator ON  | Short Press: turn the Arpeggiator on or off, and display Arp settings.<br>Long Press: display Arp settings without turning the Arpeggiator on or off.  |
| LOAD         | ON = Load Menu active  | Load a Preset onto the current Patch, on the active Layer.<br>If in LAYER menu, load a Layer setup.  |
| SAVE         | ON = Save Menu active  | Save the Patch on the current Layer to a Preset.<br>If in LAYER menu, save a Layer setup.  |
| A/B          | OFF = A<br>ON = B  | Switch between the A and B sound of a Preset.  |
| RUN          | ON = Sequencer running   | Run the sequencer.   |
| SEQ          | ON = Sequencer menu active   | Set up the sequencer   |
| REC          | ON = Recording sequence  | Record a sequence  |
| KBD          | ON = Keyboard On,<br>display KBD Menu.<br>Keys 1-16 ON = sharp/flat key  | Turn Keys 1 to 16 into a built-in keyboard   |
| COARSE       | ON = Coarse Tune<br>OFF = Fine Tune  | Switch between FINE and COARSE for OSC 1,<br>OSC 2 & OSC 3 Tune Knobs  |
| SYNC         | ON = Sync ON<br>OFF = no sync  | Hard Sync VCO 2 to VCO 1   |
| SHAPE        | ON = Wavetable selection<br>list active  | Select wavetable for OSC 3   |
| LFO 1/2      | OFF = LFO 1<br>ON = LFO 2  | Switch LFO RATE, LEVEL, SHAPE controls and LCD menu between LFO<br>1 and LFO 2   |
| SUB          | ON = SUB Osc<br>OFF = Normal Pulse   | Switch VCO 1 pulse to sub-octave square  |
| OVERDRIVE    | ON = Overdrive<br>OFF = Standard drive   | Large boost for very overdriven VCF sound  |
| TYPE (NOISE) | ON = display Type menu   | Select White/Pink/Analog XOR or AUX In for the NOISE source  |
| LFO SHAPE    | ON = display LFO Shape menu  | Select LFO waveform  |
| KEYS 1-16    | ON = Item in list / preset<br>ON = Active step<br>ON = Active step<br>ON = Sharps/ Flats<br>ON = Active MOD Source | <b>LOAD</b> operation: Short-cut to first 16 Presets or Banks in the list.<br><b>SEQ</b> operation: Sequencer position, rests or ties<br><b>RUN</b> sequencer: Sequencer step display<br><b>KBD</b> Operation: Indicates Sharps/Flats<br><b>MOD</b> Mode: Active Modulation Source |

## NINA Knobs

| SECTION     | LABEL                                   | FUNCTION  |
|-------------|---|---|
| OSC 1       | TUNE                                    | Fine tune +/- 7 semitones (1/5).<br>Coarse Tune +/- 2 octaves.  |
|             | WIDTH                                   | Shape shift from Triangle to Saw.   |
| OSC 2       | TUNE                                    | FINE & COARSE Tune for Analog VCO 2.  |
|             | WIDTH                                   | Shape shift from Triangle to Saw.   |
| OSC 3       | TUNE                                    | FINE & COARSE TUNE for Digital OSC 3.   |
|             | POS                                     | Wavetable position for Digital OSC 3.   |
|             | GLIDE                                   | Glissando/Portamento – causes smooth<br>changes in pitch between notes.   |
| MIX (OSC 1) | TEMPO                                   | Sets the playback speed of arpeggio or sequence.  |
|             | BLEND                                   | Blend between Pulse and Saw.  |
| MIX (OSC 2) | OSC 1                                   | Level of OSC 1 into mix.  |
|             | BLEND                                   | Blend between Pulse and Saw.  |
| MIX (OSC 3) | OSC 2                                   | Level of OSC 2 into mix.  |
|             | OSC 3                                   | Level of OSC 3 into mix.  |
| LFO         | NOISE                                   | Level of Noise/XOR source into mix.   |
|             | RATE                                    | LFO rate control.   |
| VCF         | LEVEL                                   | Set the LFO Level (Gain).   |
|             | RESONANCE                               | Set the VCF Resonance.  |
|             | CUTOFF                                  | Set VCF Cutoff Frequency.   |
|             | DRIVE                                   | Amount of overdrive for smooth distortion control.  |
| EG1         | EG1 CUT                                 | How much the VCF Envelope (EG1) affects VCF Cutoff.<br>MOD Mode - EG1 Level as Destination.   |
|             | ATTACK                                  | Set Attack amount for EG1   |
| EG2         | DECAY                                   | Set Decay amount for EG1  |
|             | SUSTAIN                                 | Set Sustain amount for EG1  |
|             | RELEASE                                 | Set Release amount for EG1  |
|             | ATTACK                                  | Set Attack amount for EG2   |
| OUTPUT      | DECAY                                   | Set Decay amount for EG2  |
|             | SUSTAIN                                 | Set Sustain amount for EG2  |
|             | RELEASE                                 | Set Release amount for EG2  |
|             | MAIN                                    | Main/Master level control.  |
| COMPUTER    | EFFECT / MOD PAN                        | Level of Effects mix in output. Choose type and parameters.<br>MOD Mode - PAN as Destination.   |
|             | SPIN                                    | Speed control of Stereo Infinite Panning Spin.  |
|             | MORPH / MOD EG2 LVL                     | MORPH all patch parameters between A and B sounds.<br>MOD Mode - EG2 LVL or MOPRH as Destination.<br><b>Note: Select MORPH destination via DATA WHEEL</b> |
| DATA        | LCD Navigation / General control access |   |

## Rear Panel & Connections

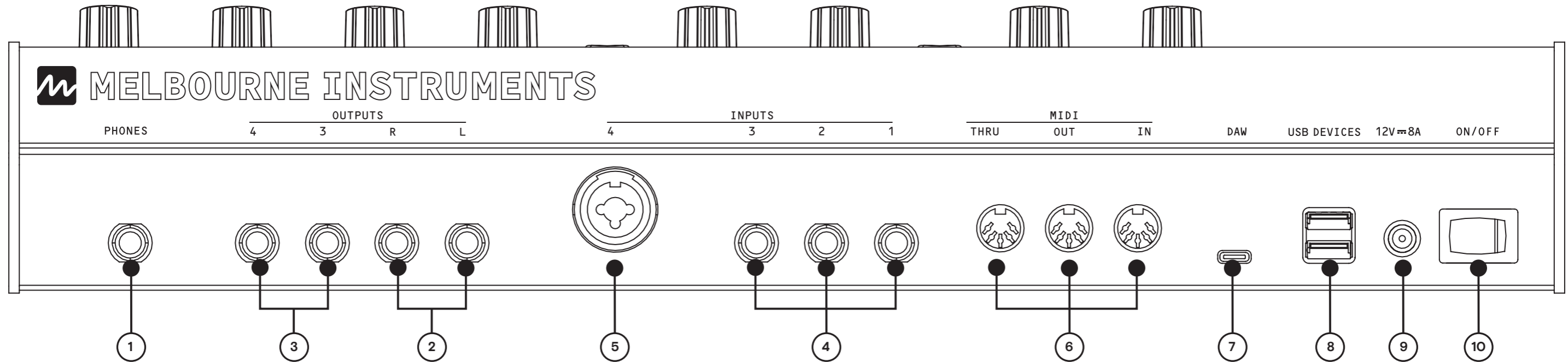

**1. PHONES:**

1/4" Headphone jack.

**2. OUTPUTS:**

Main Audio Left & Right: Line Out.  
For best results use a TRS Balanced cable.

**3. AUX AUDIO LEFT & RIGHT:**

Auxiliary Audio Out. No effects and fixed level.

**4. INPUTS:**

Inputs 1/2/3: Line level Audio or CV.

**5. INPUT 4:**

Line or Mic Level Audio or CV.

**6. MIDI:**

Standard DIN MIDI. (In / Out / Thru)

**7. DAW (USB HOST):**

USB-C connection for Mac/PC.  
NINA appears as a MIDI device.

**8. USB DEVICES:**

USB MIDI Keyboards and controllers,  
USB thumb drives.

**9. POWER INPUT:**

Use supplied power accessories only.  
12V 8A.

**10. POWER SWITCH:**

On/Off.



# Display Layout

## LOAD PRESETS Screen

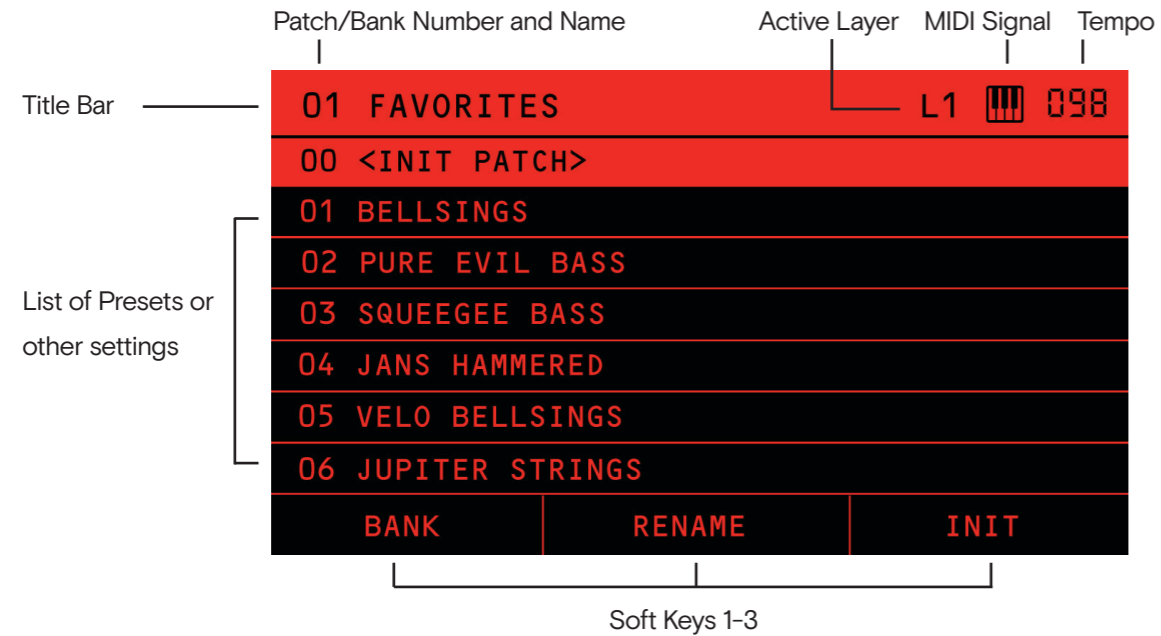

## MODULATION Screen example

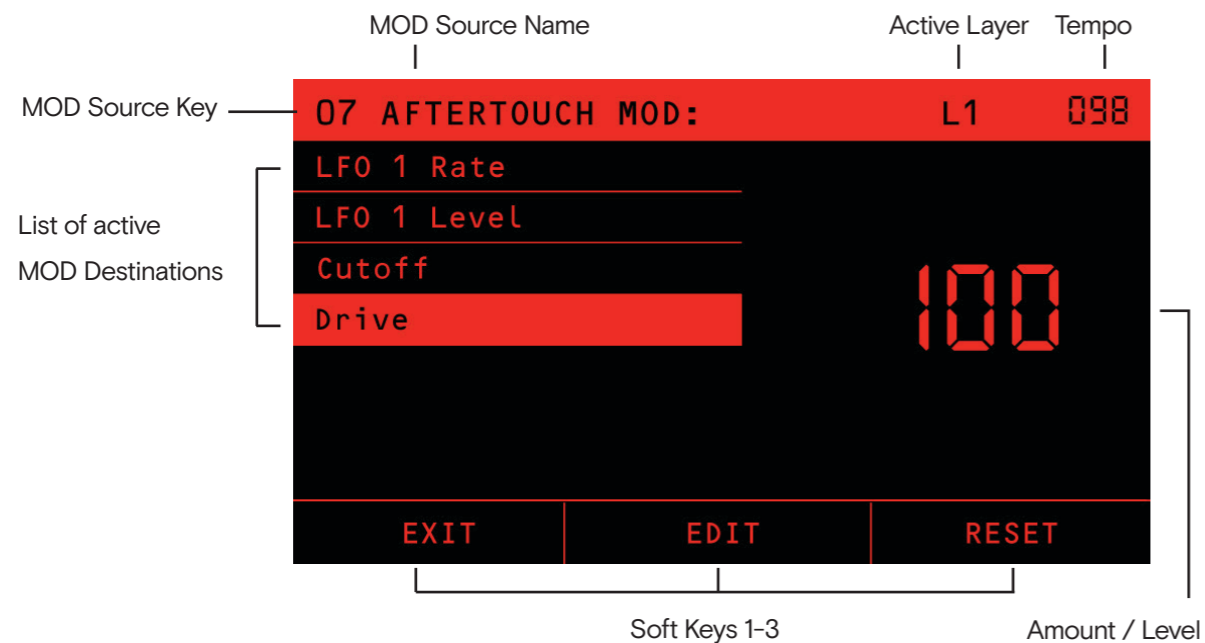

## LCD Display Context Switching

A key design goal of Nina's Display was 'no menu diving' as much as possible. One key solution to this is that the display automatically switches to display the parameters of one section, when any knobs or keys in that section are moved.

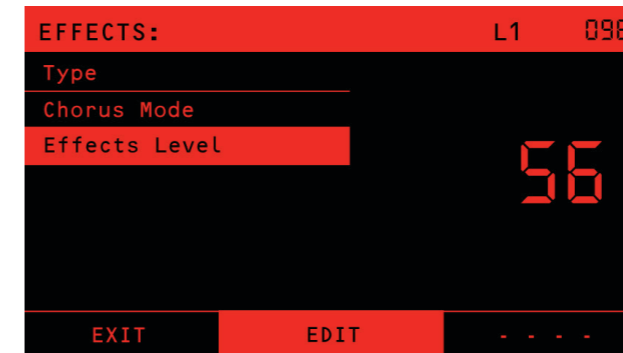

For example, if you want to set up the Effects, a very small movement of the Effects Knob will reveal all the settings to configure the Effects. You can then use the DATA Knob and the Soft-keys to adjust the effects settings:



As another example, adjusting any of the controls for OSC 1 will show all the settings for OSC 1 on the display:

When this list is displayed the DATA Knob and Soft-keys can be used to move around the list and see a numerical value. **EDIT** will let you change the setting or amount with the data knob. Note that a value change with the Data Knob will not be as high resolution as using the dedicated Knob for that setting, eg OSC 1 Level Knob has true hires control, whereas the DATA Knob will just set 0 to 100 in steps of 1.

### The EDIT soft-key has 2 modes of operation -

**LATCHED:** If you press EDIT momentarily, it will latch the data knob will adjust the current value up or down, until you press EDIT again.

**QUICK EDIT:** Press and hold down the EDIT soft-key while you turn the data knob to adjust the value without latching or needing to press EDIT a second time to exit.

## Scopes

When on the home or parameter screens Nina will display an oscilloscope showing the analog output before effects are applied. The scope has 3 options for display.

### SCOPE OSC

Normal, oscilloscope style scope

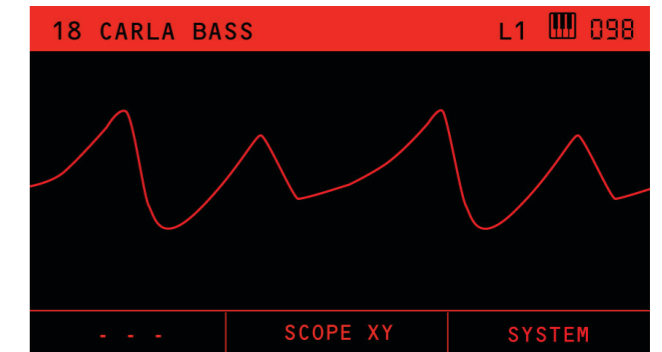

### SCOPE XY

XY or Goniometer mode. This visualises the stereo field, where the X axis is the left channel and the Y axis is the right channel audio.



### SCOPE OFF

Disable the SCOPE

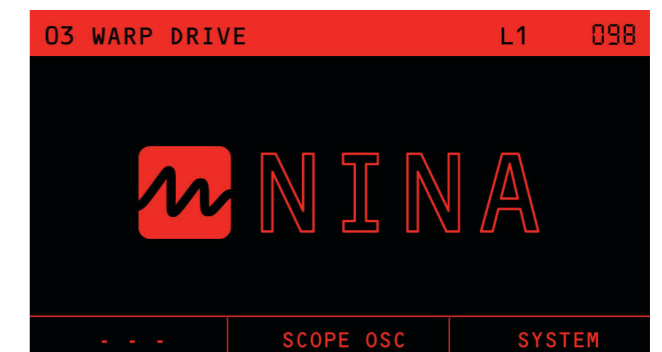



## Presets

Sounds that are saved on Nina are called **Presets** in this Guide. The current live sound that you are working on is called the **Patch**.

Nina's Presets are stored in Banks. Each Bank contains 127 Presets and there are 32 Banks. New Banks can be created, up to 127. New Banks can be added and cleared, and Banks can be imported and exported via USB Flash drives, see Bank/Patch Management on page 40 under the System menu.

The Preset data includes the Patches (A and B), Arpeggiator, Sequencer Data and Effects setup. Note that there are some global Preset parameters which are accessed via the LAYER menu, see page 31.

## Loading Presets

Press the **LOAD** Key to show the list of Presets in the current Bank. The display will show the current bank in the title bar (01 FAVORITES) and the list of Presets, starting with the last Preset loaded.

|                      |        |       |
|----------------------|--------|-------|
| 01 FAVORITES         | L1     | 098   |
| 03 BELLSINGS         |        |       |
| 04 JANS HAMMER       |        |       |
| 05 VELO BELLSING     |        |       |
| 06 JUPITER STRINGS   |        |       |
| 07 RELEASE THE BEAST |        |       |
| 08 NOT SO MINI       |        |       |
| 09 YO WOBBLE BASS    |        |       |
| BANK                 | RENAME | ENTER |

Pressing **KEYS 1-16** will quickly load the Preset at that number position on the list. If you want to go further down the list than 16, use the **DATA WHEEL** and the **LOAD soft-key** to load the Preset.

When a Preset loads, the display will remain on the LOAD screen and the LOAD Key LED will stay ON. To exit the Load screen, press the LOAD Key. You can adjust the Patch using the Knobs and Keys while still in the LOAD screen, but the LCD screen will not show the usual Patch editing information.

NOTE: the above description is the normal LOAD behavior, when the A/B Key is on A (LED Off). For a description of how B sound loading is done, see the section **Load a Preset into B** on page 17.

Nina will also exit LOAD mode when you press any of the following keys: SHAPE (wavetable), TYPE (Noise) or LFO SHAPE. Once pressed, these keys show relevant options.

## Initialize Preset

To initialize a Preset to a very simple state simply choose the INIT PATCH Preset.

Once initialised, The Mod matrix has everything off except vital minimum mappings. The filter is open and envelopes are very simple. OSC1 is the only audible oscillator and it is a sawtooth at max volume.

|                    |        |      |
|--------------------|--------|------|
| 01 FAVORITES       | L1     | 098  |
| 00 <INIT PATCH>    |        |      |
| 01 BELLSINGS       |        |      |
| 02 PURE EVIL BASS  |        |      |
| 03 SQUEEGEE BASS   |        |      |
| 04 JANS HAMMERED   |        |      |
| 05 VELO BELLSINGS  |        |      |
| 06 JUPITER STRINGS |        |      |
| BANK               | RENAME | INIT |

## Banks

The **BANK soft-key** allows you to access Presets from another Bank. Pressing **BANK** will display the list of available Banks:

Press **ENTER** to open the selected bank and show the Presets in that bank. If you press **EXIT**, you will exit Load mode and the display will return to the Home screen.

|              |        |       |
|--------------|--------|-------|
| BANKS        | L1     | 098   |
| 01 FAVORITES |        |       |
| 02 BASSES    |        |       |
| 03 LEADS     |        |       |
| 04 KEYS      |        |       |
| 05 PADS      |        |       |
| 06 EFFECTS   |        |       |
| 07 USER 01   |        |       |
| EXIT         | RENAME | ENTER |

## Rename

The **RENAME soft-key** allows you to rename Preset or Bank names shown in the list.

Use the Data Wheel to scroll the cursor left or right. Press and hold **EDIT** while you adjust the data knob to change the letter or number at the current cursor position. Note that all the letters to the right of the cursor are greyed out. The greyed out letters will be trimmed off the name when you press ENTER. If you want to retain all character in current name, move the cursor to the end before you press ENTER.

Press **BACK** to cancel the rename operation and return to the Bank or Preset list.

|             |      |       |
|-------------|------|-------|
| RENAME BANK | L1   | 098   |
| FAVORITES   |      |       |
| A           |      |       |
| B           |      |       |
| C           |      |       |
| D           |      |       |
| EXIT        | EDIT | ENTER |

## Saving Presets

Saving Presets is very similar to loading.

Press the **SAVE** key to show the list of Presets in the current Bank.

|                      |       |      |
|----------------------|-------|------|
| 01 FAVORITES         | L1    | 098  |
| 03 BELLSINGS         |       |      |
| 04 JANS HAMMER       |       |      |
| 05 VELO BELLSING     |       |      |
| 06 JUPITER STRINGS   |       |      |
| 07 RELEASE THE BEAST |       |      |
| 08 NOT SO MINI       |       |      |
| 09 YO WOBBLE BASS    |       |      |
| BANK                 | - - - | SAVE |

The list will always start from where you last loaded. If you simply wish to overwrite the Preset, press **SAVE**. Otherwise scroll down to a different location, or use **BANK soft-key** to navigate to a different Bank and Preset location.

When you press **SAVE**, you will be prompted to change or update the name. Use the DATA knob to select the letters and EDIT to change them.

|                 |      |      |
|-----------------|------|------|
| SAVE PRESET     | L1   | 098  |
| JUPITER STRINGS |      |      |
| A               |      |      |
| B               |      |      |
| C               |      |      |
| D               |      |      |
| EXIT            | EDIT | SAVE |

When you press **SAVE** again, Nina will briefly inform you that the Preset has been saved. If you changed the name, the new name will be saved to the Preset and displayed on the Title Bar. The LCD will then return to the home screen, and **SAVE** mode will be exited.

If you press **BACK**, you can either navigate to a different Preset location, or **EXIT** to the home screen. You can also exit the **SAVE** mode without committing changes by pressing **SAVE** key.

## Import & Export Presets

Banks of Presets can be imported and exported from Nina to .zip files stored on a USB flash drive. See section Bank/Patch Management on page 40, under System Functions.

## Morphing and A/B Compare

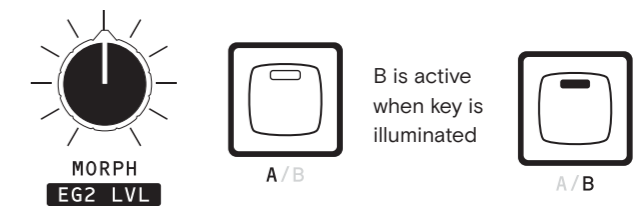

All Presets have the ability to store 2 sounds, referred to here as the **A sound** and the **B sound**. The main use for these 2 sounds are for comparing an original sound with a modified version you are working on (A/B compare), or for exploring new sounds that are a morph between these A and B sounds.

The **A/B key** switches between the sounds. If the A/B Key LED is OFF, you are editing the A sound; if the LED is ON, you are editing the B sound. If you wish to quickly try this, press the A/B key, and see how the knobs will jump between the 2 sounds (assuming A & B sounds are already set).

Morph is a great way to explore new sounds for Preset creation. It can also be used dynamically in playing live music or creating interactive cinematic sound-scapes as you play. The Morph position can also be automated using a DAW.

As you press the A/B Key, you will notice that the Morph Knob jumps between fully-left and fully-right. When you turn the Morph knob, the sound will morph between the A and B sounds according to the position of the Knob.

The morph is not a crossfade between the 2 sounds, it is a creating entirely new timbres between them. The morphed sound is made by smoothly interpolating every parameter between the settings in the 2 patches, including the entire Modulation Matrix.

**Some settings cannot be morphed in the same way, so work a bit differently.**

| Setting                      | Morph Operation   |
|------------------------------|---|
| <b>OSC 3</b>                 | Crossfades between the sound of OSC3 on A and B                                 |
| <b>COARSE Tune</b>           | Steps between the octaves on A and B in even steps divided over the Morph Range |
| <b>SUB Oscillator Enable</b> | Steps between the A sound and B sound setting at the 50% Morph position         |
| <b>SYNC Enable</b>           | Steps between the A sound and B sound setting at the 50% Morph position         |
| <b>NOISE Type</b>            | Steps between the A sound and B sound setting at the 50% Morph position         |
| <b>OVERDRIVE</b>             | Setting is always the same on A and B. Does not morph.                          |
| <b>EFFECTS</b>               | Setting is always the same on A and B. Does not morph.                          |
| <b>TEMPO, ARP, SEQUENCER</b> | Setting is always the same on A and B. Does not morph.                          |

Operating the Morph control will bring up the Morph menu on the LCD.

Below: **STORE TO A** soft-key shown because A/B is off. The Mode setting allows you to select Dance or DJ mode.



## Dance Mode

In Dance mode, the knobs will all move to show their positions in the Morph, and you can edit that morphed sound as you go.

As you morph between the two, you can also move any of the front panel knobs to lock in that parameter. For example, if you are morphed ¼ of the way from A to B, and you adjust the Resonance Knob, then when you move the morph knob again, the Resonance Knob will not move anymore.

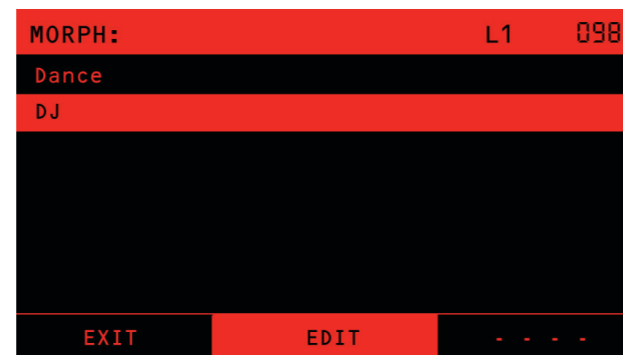

## DJ Mode

In DJ mode, the Morph knob will morph between the sounds, and you will hear the morphed sound, but the knobs will not move. The controls will either be editing the A or B sound, depending on the A/B Key.

TIP: DJ Mode works well if you are automating the Morph control from a DAW and want to use the patch editing knobs at the same time.

In Dance mode, you edit the Morphed sound if you adjust with the knobs, but in DJ mode you edit the original A and B sounds when you adjust the knobs.

## Store to A/B

At any point you can save the morphed sound to the A or B Patch by pressing the STORE TO A or STORE TO B soft-key (determined by A/B key).

TIP: Always take notice of the state of the A/B Key before you start to Morph, because that is where you will be able to save it.

Below: **STORE TO B** soft-key shown because A/B is on.



## Load a Preset into B

A great way to explore new sounds is to load two completely different sounding Presets into the A and B sounds, and morph between them.

You can load a Preset into the B sound using the A/B Key in combination with LOAD. To be specific: you can load the "A" sound from another Preset into the current Patch B sound.

A normal Preset LOAD, as described in the section on Loading Presets on page 14, is one where the A/B Key is on A (LED off). In a normal load, the full Preset with both A and B sounds will be loaded.

However, if the A/B Key is on B (LED on) when you load, then the Preset you selected will just load into the B sound. The A sound and the rest of the current Patch will remain unchanged.

When the A/B Key is on B, the soft-key for loading changes to **LOAD B**.



## Patch Design

### Analog VCOs

Nina has two Analog VCOs, OSC1 and OSC2. These are discrete-transistor VCOs which generate a Sawtooth/Triangle shape and a Pulse Shape.

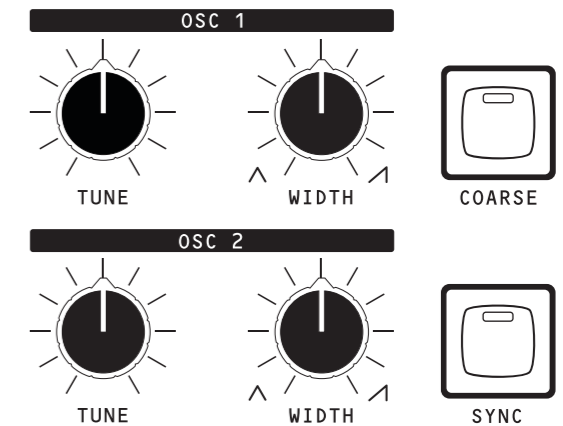

**The control of Nina's sawtooth to triangle wave shape has a unique feature —**

Most existing synthesizers do a crossfade between triangle and sawtooth when you adjust the shape control. Nina's oscillators do a smooth shape transition between triangle and saw, which follows the pulse width. This creates a unique set of timbres between the two shapes.

The following diagram shows a picture of how the Width Knob changes the shape of the Saw/Triangle and Pulse

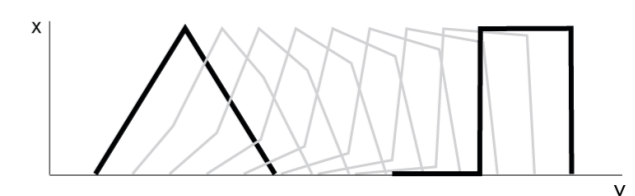
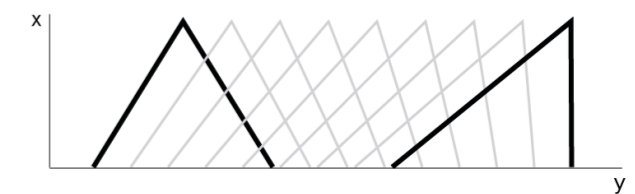

TIP: Modulate the Width with an LFO to create interesting phaser-like bass sounds.

The Blend control is a crossfade between the Saw/Triangle output and Pulse output of each VCO.

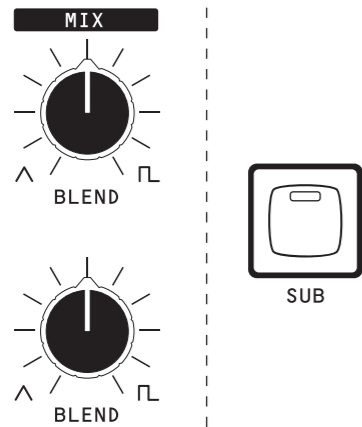

The **SUB key** makes OSC 1's pulse output drop 1 octave and become a square wave.

The **SYNC Key** makes OSC 2 hard sync to OSC 1. This means the every time OSC 1 restarts its waveform it forces OSC 2 to restart.

The **TUNE Knob** is used for either fine or coarse tune adjustment, as determined by the state of the **COARSE Key**. If the Coarse Key LED is off, the TUNE Knob is a fine tune control in cents (1/100 of a semitone), with a range of +/-7 semitones (700 cents) ie a perfect fifth.

If the COARSE Key LED is on, the TUNE Knob is an octave transpose 5 position switch with a range of +/- 2 octaves.

## Digital Oscillator

OSC 3 is a Digital Wavetable Oscillator.

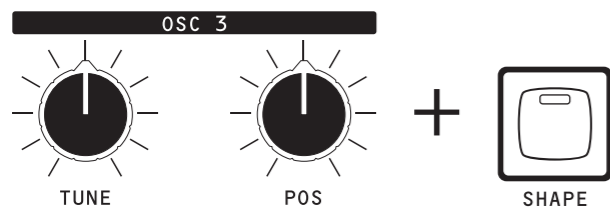

Nina's included factory wavetables cover a range of styles, from retro 80s style to modern high resolution interpolated waveforms. Wavetables can be imported and exported, and formats from popular software synthesizers are supported. See **Wavetable Management** for more details.

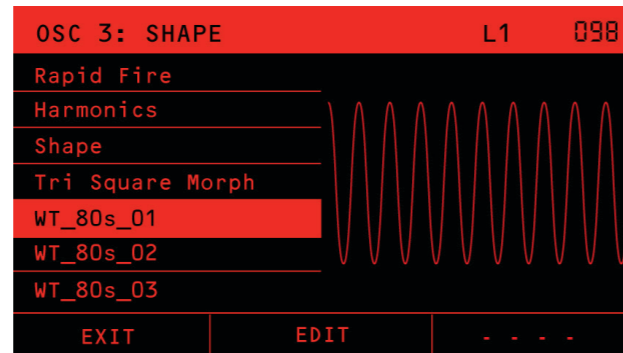

The **SHAPE Button** displays the currently selected wavetable. The visualiser scans forward and backward through all the waves in the table.

The **TUNE Knob** performs the same coarse and fine tune functions as it does with OSC 1 and OSC 2.

The **POS Knob** sets the wavetable position. You can manually adjust the position and the position is often assigned as a modulation destination to let the wavetable sound evolve as it plays.

The wavetable **Interpolate** option determines how the wavetable sounds. If Interpolation is on, the wavetable Position (POS) will smoothly transition the sound between the wavetables. If it is off, then it will step from one to the next. How 'steppy' the sound is will depend on many steps the chosen wavetable contains.



## Noise and Other Sources

In addition to the three Oscillators, sound sources labelled as **NOISE** can be mixed into each voice.

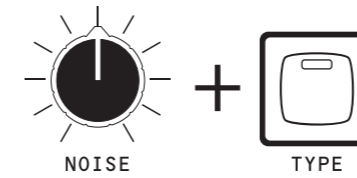

The **TYPE Key** displays a list of the sound sources that can be used:

### XOR

This source is an analog signal which is a ring modulation of the Pulse outputs of VCO1 and VCO2. This ring modulation is created by a discrete transistor XOR gate. This kind of sound has a very particular and unusual timbre.

### White

This source is digitally generated white noise. This is full audio bandwidth bright noise.

### Pink

This source is digitally generated pink noise. Pink noise has less high frequency energy, so sounds darker and less harsh than white noise.

### AUX In

Selecting this source allows the Analog Inputs (line level or MIC) to be inserted into the front end of the voice. This lets you mix in external sources to each voice and pass through the overdrive, VCF, VCA and effects.

Operating the NOISE Knob brings up the Noise settings menu, which has some further options.



## Input Select

This option chooses which analog inputs are routed into the Aux In:

| Setting        | Description   |
|----------------|---|
| 1, 2, 3 or 4   | This selects Analog Input 1, 2, 3 or 4 as a mono source   |
| Stereo 1-2     | This selects Analog Inputs 1 & 2 as a stereo pair (Left & Right respectively) into pairs of voices. In order to get the voices to work as a stereo pair, set Unison Voices (see page 33) to a multiple of 2. To get a stereo spread, set Panner Number to 2, and mode to Spread or Ping-Pong (see page 33). |
| Stereo 3-4     | Works the same way as Stereo 1-2, but uses inputs 3 & 4 as Left & Right respectively.   |
| Stereo Out 1-2 | This routes Nina's Channel 1 & 2 outputs back to the voices in a stereo pair to create a feedback loop.   |

## Ex Input Gain

Adjusts the gain on the analog inputs.

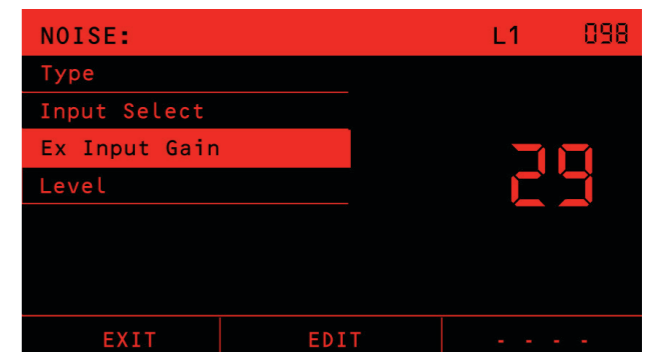



## Voice Mix

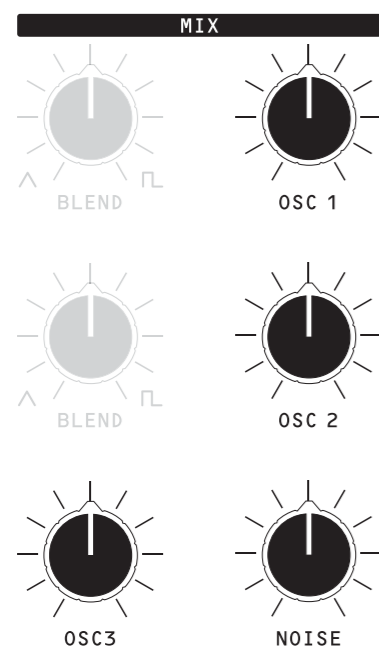

All of the four sound sources: OSC 1, OSC 2, OSC 3 and NOISE are mixed together using their level control Knobs. Use these to adjust the timbre of the sound.

TIP: To get the best sound out of the MIX section, set the dominant oscillator's level control to its maximum and adjust the other oscillators down relative to that. This will give the best dynamic range and SNR.

## Drive & Overdrive

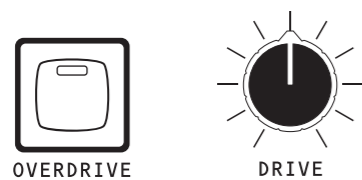

The mixed signal goes through an overdrive circuit before it goes into the VCF. The **DRIVE Knob** controls the level of the overdrive. The normal 12 o'clock position of the DRIVE knob will give a smooth sound with no overdrive for a typical level coming out of the mix. As you turn the drive up, you will hear the sound thickening as the overdrive level starts to distort the input of the VCF. This is often used for adding character and weight.

If the sound from the mix is quite high level because there is a lot being added together, and you hear a bit of overdrive character in the signal that you don't want, you can turn the overdrive to the left of 12 o'clock to reduce the overall level and make a cleaner sound.



The **OVERDRIVE Key** is used to apply a large signal boost. With this on, the signal will always sound overdriven, and DRIVE knob range adjusts from moderate to extreme overdrive.

## Filter / VCF



Nina's VCF is a classic 4 pole transistor ladder filter as designed by Robert Moog in the 1960s. The **RESONANCE Knob** sets the amount of resonance, and the filter can self-oscillate.

The **CUTOFF knob** sets the filter cut-off frequency. Note that the frequency is not precisely tuned to exact semitones. Instead, it is allowed to have a bit of natural variation due to each analog voice circuit's individual characteristic. This variation adds character and depth as different voices are allocated to different notes played, but it also means you cannot use the self-oscillation of the filter to play in-tune notes.

The **Key Track** setting, which is shown (only) on the LCD, determines how much the VCF cut-off frequency is affected by the notes played. Key Track is a value from -100% to 100%. At 100% the filter will change the cut-off frequency by fully tracking the notes played. At 50% the filter will adjust by half the note change.

For example if you play a note one octave higher, the filter cut-off will move half an octave higher. The Key Tracking can be negative, which means the cut-off frequency will move down as the note numbers go up, and vice-versa.

NOTE: The Key Track setting is just a shortcut to the modulation matrix. It is the controlling the modulation setting Source as **KBD** and modulation destination as **CUTOFF**.

## Filter Envelope EG1

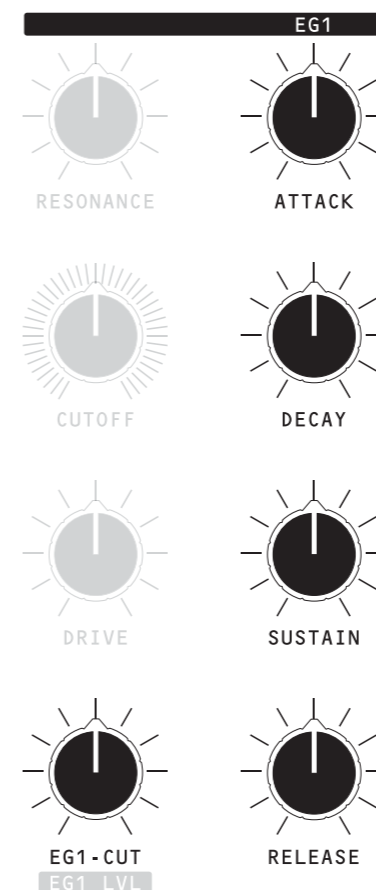

Envelope Generator 1 (EG1) is a standard Attack-Decay-Sustain-Release (ADSR) envelope generator, usually assigned to control the Filter cut-off.

The **LEVEL** option (Shown in the LCD only) adjusts the output gain of the envelope.

The **RESET** option (shown in the LCD only) chooses what happens if a note is still being heard when a new one is played.

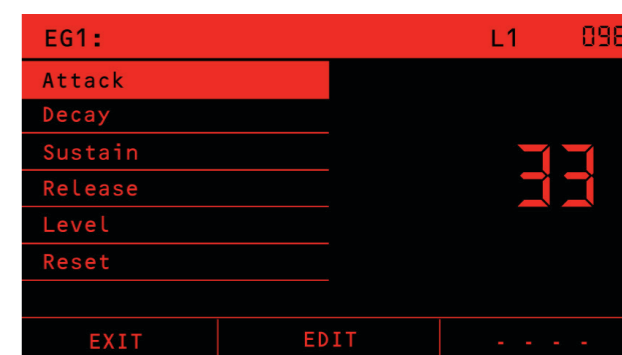

If **RESET** is **ON**, then the old note will be instantly turned off, and the envelope will start the Attack phase from zero.

If **RESET** is **OFF** the old note is not silenced, instead the envelope starts the Attack phase from the tail of the previous note.

## EG1-Cut



The dedicated **EG1-CUT knob** sets the amount that the envelope affects the VCF cut-off. It has a range of -100 to +100, so the envelope can move the cut-off frequency down (negative values) or up (positive values) as the note plays. The range is curved, so small values, say under 10, move the filter less than a semitone, whereas 100 moves the filter 127 semitones with the envelope.

## VCA EG2

Envelope Generator 2 (EG2) is also a standard ADSR envelope generator, and is always (note: always) assigned to control the final VCA in each voice. You can also assign EG2 to control any other modulation destination in the mod matrix.

The LEVEL option (Shown in the LCD only) adjusts the output gain of the envelope.

The RESET option (shown in the LCD only) chooses what happens if a note is still being heard when a new one is played.

If RESET is ON, then the old note will be instantly turned off, and the envelope will start the Attack phase from silence. This makes an abrupt transition at each note start. This is a common setting for bass sounds, where the attack phase needs to be heard on each note.

If RESET is OFF, then the old note is not silenced, instead the envelope starts the Attack phase from the tail of the previous note. This makes a smooth transition from one note to the next, especially when the envelope has a slow release.



The DRONE option is used for special cases. With drone ON, the VCA is always at full volume. There is no Attack, Delay, Sustain or Release phase, the voices continuously send their sound out. This is often used in combination with modular synth setups.

## Glide/Portamento

The **GLIDE Knob** controls how quickly the pitch of notes changes as different notes are played. A glide setting of 0 makes the pitch change instantly, like a piano does. As you increase the setting, the pitch change between notes will take longer, which is a portamento effect.



The **Glide Type** option shown on the LCD is selectable between Linear, Logarithmic and Legato Linear. The choice between Linear and Logarithmic comes down to the style of playing, sound and personal preference. The 'Legato Linear' glide type changes the glide depending on whether the playing is legato or not. If the notes are played legato (a new note is played before the previous note is released), then glide is done between the notes. If the previous note is released before a new note is played (non-legato or staccato), then glide is not done and the pitch steps immediately to the new note.



## Stereo Infinite Panning

Nina has advanced panning capabilities, far more than a simple left-to-right pan. There are a powerful set of functions to allow control and movement in the stereo field in normal and anti-phase. We call this **Stereo Infinite Panning**.

Each voice in Nina has two final VCAs which are a stereo pair. The VCAs are a custom four-quadrant (aka through-zero or attenuverter) circuit, which allows for each voice to be panned beyond the apparent edges of the speakers, or behind the listener with headphones.

This is based on a psycho-acoustic effect which is sometimes used in mastering and surround sound. To explain this effect, imagine a hard left pan. This is full level on the left and zero on the right. From this, if you then invert (anti-phase) the signal in the right channel and increase its level, then it will appear that the sound is moving past the left of the left speaker, or behind your head if you are wearing headphones.

Note that this is an illusion, so the effect is not as precise as a real bee buzzing around you. However, the effect does give a huge stereo image. Experiment with it and see how it affects the sounds you make.

The Pan value which comes out of the modulation matrix sets the position of each voice. Hard left is -100, center is 0 and +100 is hard right. The range of -100 to -200 goes into anti-phase, giving the effect of being behind the headphones or beyond the speakers.

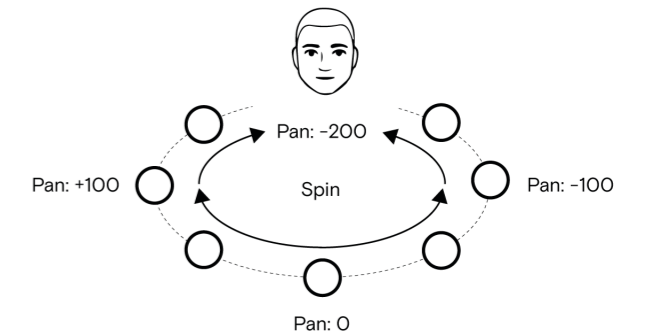

There are a number of tools you can use to position multiple voices around this 360° field, control their stereo spread and spin them in the field. These are explained in the following sections.

## The Panner

As each note is played, the panner decides what the pan position of that note will be. The settings for the Panner are global parameters in the Preset and are accessed via the LAYER key.

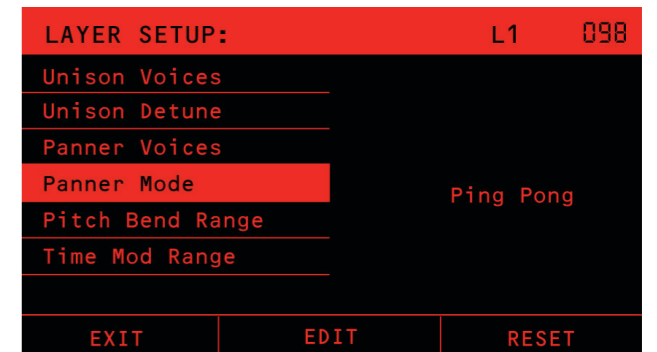

There are three Pan Modes, and a Pan Number.

- **Pan Mode OFF** sets no panning. The starting Pan position of every note is 0 (center).
- **Pan Mode SPREAD** plays each note evenly across the Left to Right stereo field, according to the number set in Pan Number. For example if Pan Number is set to 3, the notes will be placed evenly at Hard Left, Centre and Hard Right. The order is always from left to right and is allocated as notes are played.
- **Pan Mode PING PONG** will make each note's position alternate Hard Left, Hard Right, Hard Left and so on

The Panner is only the first step in deciding a note's pan position. The settings in the modulation matrix determine how the Panner values control the actual position in the stereo field.

## MOD Matrix Pan

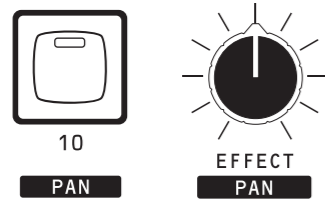

Each voice's final pan position at the audio outputs is determined by the modulation matrix **PAN destination**. The Modulation matrix is described in the section Modulation on page 25.

The **PAN source** key (Key 10) is the Panner, as described in the previous section. In order to make the Panner affect the Pan position, make an assignment from the PAN (Panner) source to the PAN destination.

The amount set in the Mod Matrix determines how wide the stereo spread is. A modulation amount of 100 gives 100% of the spread defined by the Panner, 50 give 50% and 0 gives no spread so all voices will be dead center. The diagram on next page depicts this example.

Pan Mode: Spread | Pan Number: 3

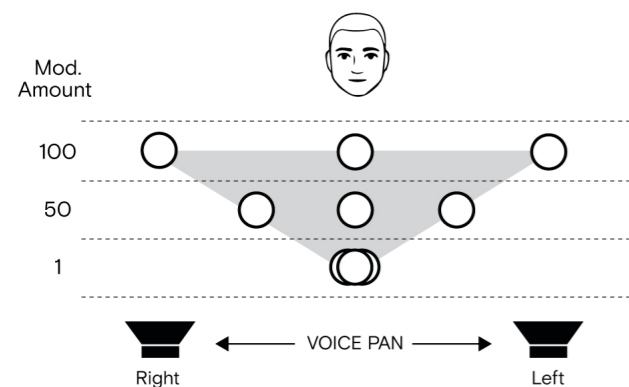

Note that the Mod Matrix can make the Pan position move into the antiphase region. If the sum of all the mod sources is greater than 100 at the Pan destination (or less than -100), then the Pan position will be in the antiphase region. For example, if you had a Mod Amount of 100 in the above diagram and you also have a Sine LFO going to the Pan with a Mod Amount of 100, then the peak pan position will be  $100+100 = 200$ , giving the sound an anti-phase effect.

## Unison

Unison operation plays each note with multiple voices, to create a thicker, more powerful sound. Unison repeating

of the notes happens before the Panner, so the Panner will affect each of the unison voices separately.

For example, if Unison Voices is set to 3 and the Pan Spread is set to 3, then each note plays with 3 voices across the stereo field left, center and right.

## Spin

The last part of Nina's Stereo Infinite Panning capabilities is spin. Spin is applied after the modulation matrix, so spins all the notes playing together.



For example, if you have five notes playing in Unison, the Panner set to Spread and the Panner -> Pan Mod Matrix amount is 100 left to right in a unison pan, the stereo field will sound as shown in (a) diagram below. Spin will spin all of that group of 5 around the stereo field while holding the same apparent distance between them. The SPIN knob determines the speed and direction of the spin. Spin is clockwise for positive and counter-clockwise for negative amounts.

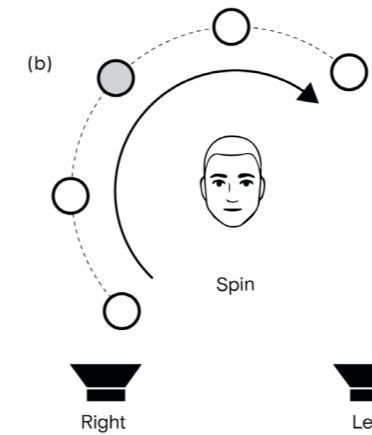
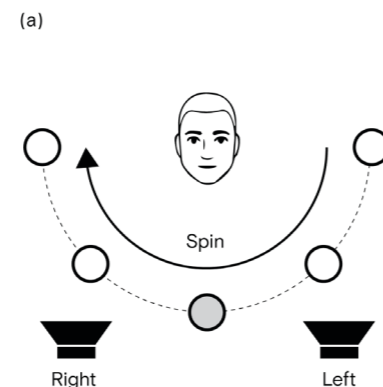

Note that the diagram shows the sounds coming from behind the listener, which is not exactly correct as the effect is less distinct at the back. However, it is a very wide stereo effect. Play with this effect to hear how it sounds. Imagine what it would sound like in a stadium or club environment.

## Modulation

Nina has a powerful modulation matrix setup, where virtually anything can modulate anything else. It does not have a limit on the number of modulation connections (commonly called slots) that can be made.

The common problem with these kind of modulation capabilities is that synthesizers typically just show a list of modulation Source to Destination settings, and looking through this list is unintuitive and hard to navigate as the list grows.

Nina addresses this problem by using the capabilities of its Motorized Knobs and the 16 Keys along the bottom to quickly view and modify all the active matrix connections. See MOD Mode on page 27 for a full description.

Modulation is additive, except for the Keyboard Velocity. For example if the Filter cut-off level is 50, and the modulation matrix assigns the MOD wheel with an amount of 25, then the MOD wheel will vary the cut-off from  $(50+0)$  to  $(50+25)$ . Modulation destination amounts are positive and negative, so they can be made to increase or decrease the value.

The Keyboard Velocity is additive to all destinations except the Envelope Generators. For EG1 and EG2 the Mod Matrix sets how sensitive to velocity the envelope is. An assignment of 0 makes EG1 and EG2 not sensitive to velocity, so they will play at full amplitude. An assignment of 100 makes EG1 and EG2 100% sensitive, so will play full range from quiet to loud. In between this, for example an assignment of 50 will make the notes play between 50% and 100% amplitude according to the velocity.

Note that the Analog VCOs are not available as Modulation Sources. If you want FM type sounds, try using OSC 3 (digital oscillator) as the modulation source and the Analog VCOs as the destination.

Modulation is generally bipolar, so the range has negative and positive amounts. This combined with Nina's four quadrant (through-zero) VCAs, means that negative Mix amounts will invert the signals from the VCOs into the mix. For example, if you set the Mix Level of OSC 1 at 0, it will be silent. If you add a modulation source of LFO1 to the OSC 1 Mix Level with an amount of 50, then OSC 1 will be heard in the mix, going from in-phase at 50% level (when the LFO is at +50), down to zero level (when the LFO is at 0), and then up to 50% level anti-phase when the LFO is at -50.

The front panel offers direct controls for LFOs and EG1-Cut modulation.

## LFOs

The **LFO1/2 Key** Switches all the LFO controls between LFO1 and 2. The LED will be OFF for LFO 1 and ON for LFO 2.

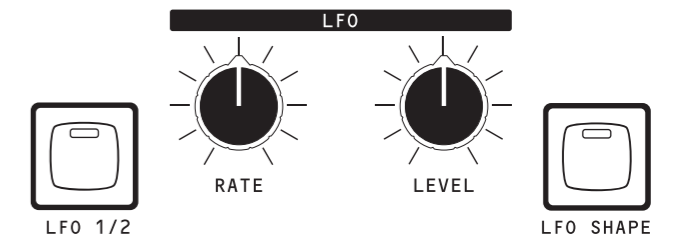

The title bar on the screen will show LFO 1 or LFO 2 accordingly, and the knobs will jump to the correct positions for the RATE and LEVEL of the LFO.



The **LFO Rate** is set by the **RATE knob** and has a frequency of  $1/33$  Hz at 0 to 30Hz at 100. The LFO Rate is also a Modulation destination, so it can be made a lot faster by adding a SET amount in the Mod Matrix to the LFO Rate.

The LFO Level knob sets the amplitude of the LFO from 0 to 100. Note that amplitude is set before the LFO is sent into the Mod matrix, so it combines (multiplies) with the amount set in the mod matrix. The LFO is bipolar, so for an amplitude of 100, it will range from (100 to +100). If you wish to make a unipolar LFO, or offset the waveform, you can apply a SET to add a value to the same destination. See SET in the Modulation Sources below for more details.

The **LFO SHAPE Key** sets the LFO waveform shape. The choices are **Sine**, **Triangle**, **Square**, **Ramp Up**, **Ramp Down** or **Random**.

Adjusting any of the LFO settings will display all the LFO settings on the LCD, including some which can only be accessed using the Data Knob and EDIT.



If **Retrigger** is On, then the LFO waveform will restart with each note played, if it is Off then it will free-run, but each voice will have its own LFO running independently. If it is **Global** then this LFO will feed every voice at exactly the same amplitude and waveform phase, so they will all move together.

If **Tempo Sync is Off**, the LFO will not be synchronous to anything else in system, and the RATE Knob sets the tempo.

If **Tempo Sync is On** then the LFO will follow the tempo of incoming MIDI clock pulses the Arpeggiator and Sequencer (or MIDI Clock if enabled). When this sync is on, the LFO Rate knob chooses a multiple of the Tempo, as shown in this table:

| Sync Rate | Tempo to LFO Frequency Multiplier |
|-----------|-----------------------------------|
| 0.125     | 1/8 (0.125)                       |
| 0.25      | 1/4 (0.25)                        |
| 0.5       | 1/2 (0.5)                         |
| 1d        | 2/3 (0.667)                       |
| 1         | 1                                 |
| 2d        | 4/3 (1.333)                       |
| 2         | 2                                 |
| 4d        | 8/3 (2.667)                       |
| 4         | 4                                 |
| 4t        | 4x(4/3) = 16/3 (5.333)            |
| 8         | 8                                 |
| 8t        | 8x (4/3) = 32/3 (10.667)          |
| 16        | 16                                |
| 16t       | 16x (4/3) = 64/3 (21.333)         |
| 32        | 32                                |
| 32t       | 32x (4/3) = 128/3 (42.667)        |

## MOD Mode

Nina has a quick and simple way to access the Modulation Matrix using the motorized knobs to expose the settings and see how a sound is created.

Press the **MOD Key** to enter modulation mode. In modulation mode, all of the Knobs change their function. The MOD LED will blink, as a reminder that the Knobs are not doing their normal function.

In MOD mode, the 16 red keys along the bottom select the **Modulation Sources**.

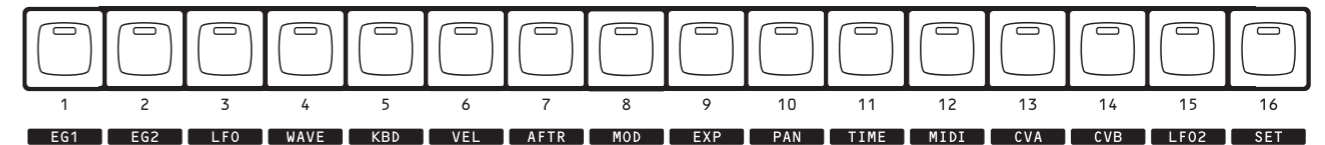
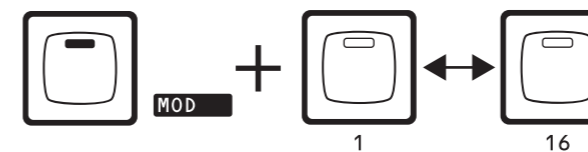

As you press these keys the corresponding Knobs will move into position according to how much this source affects the destination at each Knob.

For example if you press **Key 1 (EG1)**, the CUTOFF Knob will move to the amount that EG1 affects the Filter Cut-off frequency. The CUTOFF knob has a center detent, at zero, so allows a range of -100 through 0 to 100. The negative range makes the EG1 envelope move the cut-off frequency down, and positive makes it move up.

NOTE: When a modulation source is selected, it cannot modulate itself as a destination, so the knobs at that destination will control their usual settings in the patch. For example, if LFO is selected as a source, then the LFO1 RATE and LEVEL controls will affect LFO1. This means you will not have to exit the MOD mode to adjust LFO1 and hear the effect on the patch. Likewise if EG1 is selected as the source, then the ATTACK, DECAY, SUSTAIN and RELEASE controls for EG1 will adjust the envelope as usual in patch editing.

The Title Bar shows which source has been selected and the list shows each destination that is affected by this source. Use the DATA Wheel and the EDIT soft-key to adjust the value.

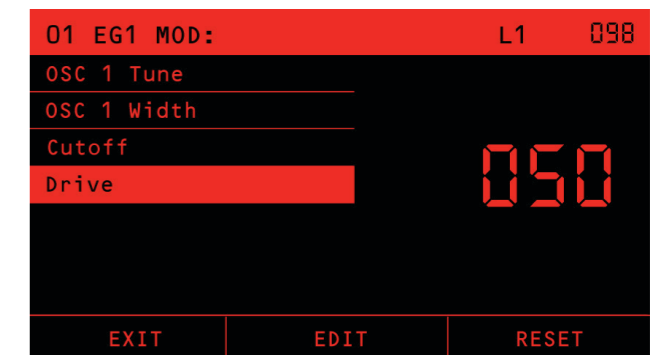

NOTE: The corresponding control panel knob is a higher resolution than data wheel, and offers greater control than setting the value in steps of 0 to 100.

The **RESET soft-key** is a quick way to zero the modulation amount to the selected destination in the list.

TIP: A quick step through the Keys 1 to 16 in MOD Mode is a great way to get an overview of how a Preset has used the modulation matrix to create its sound.



## Modulation Sources

| MOD Key # | Name | Description  |
|-----------|------|--|
| 1         | EG1  | The ADSR Envelope from Envelope Generator 1. This envelope is very commonly assigned to the Filter Cutoff frequency, but it does not have to be.   |
| 2         | EG2  | The ADSR Envelope from Envelope Generator 2. This envelope is always assigned to the output stereo VCA from each voice at 100%. This is not shown in the list on the LCD, because it is a fixed connection, always on. You can also assign it to any other destination.  |
| 3         | LFO  | LFO 1 output modulation source. This can be assigned to any destination, including the rate and level of LFO 2.  |
| 4         | WAVE | The OSC3 Wavetable waveform. An example use is assigning this source to modulate OSC1 (VCO 1) Tune can create FM sounds.   |
| 5         | KBD  | The MIDI Note Number. This is normally assigned 100% to the Tune destination of OSC1, 2 and 3, so that the keys play notes at the correct frequency. An example use is assigning this source to the PAN destination to create a sound that pans left to right as you play from the left to right hand side of an attached keyboard.  |
| 6         | VEL  | The MIDI Note Velocity. An example use is to assign to the EG2 sustain to make notes play louder or softer according to how hard or softly you play. This modulation source works differently.   |
| 7         | AFTR | The MIDI Channel or Polyphonic Aftertouch. This is the pressure on the keyboard after notes are pressed down. An example use it to assign to Filter Cutoff to open the filter by pressing on the keyboard.   |
| 8         | MOD  | The MIDI Mod Wheel. A common use is to assign this to the LFO1 or LFO2 Level.  |
| 9         | EXP  | The MIDI Expression Control. This is MIDI controller number 11. The MIDI specification defines this as "Expression is a form of volume accent above the programmed or main volume", however it is a normal MIDI controller and can be assigned to any destination.   |
| 10        | PAN  | The Panner. See section Stereo Infinite Panning on page 19 for details. Note that this is not the MIDI Pan control.  |
| 11        | TIME | Is a constantly increasing level from 0 to 100 which acts like an envelope with only an Attack phase. Time starts with a value of 0 when a note is played and the attack phase starts, and ramps upwards with an inverse exponential (RC type) shape. The speed or rate of attack (1 Time Constant or 63% of amplitude) is around 60ms at the fastest rate of 0, up to around 4 minutes at the slowest rate of 100. The time amount is best set by ear, and the Time Rate is accessed in the Layer menu, see Time Mod Rate on page 33. |
| 12        | MIDI | MIDI controller CC Number 2. This is defined as the "Breath controller" in the MIDI Specification. It is commonly assigned to a ribbon controller on MIDI keyboards.   |
| 13        | CVA  | Control Voltage A. The mapping of this to an analog input is described in section CV A and CV B Source on page 32.   |
| 14        | CVB  | Control Voltage B. The mapping of this to an analog input is described in section CV A and CV B Source on page 32.   |
| 15        | LFO2 | LFO 2. See the section on LFOs above for details.  |
| 16        | SET  | Is a constant value. This value is added onto the destination at all times. For example if you want to make the LFO values go between 0 and 100, instead of -100 to 100, make the LFO amplitude 50, and add a SET of 50 to the same destination as the LFO.  |

## Modulation Destinations

| Name         | Function   |
|--------------|--|
| OSC 1 TUNE   | Pitch of VCO 1. The response of VCO 1 to the amount received is shaped so that small values give a small detune while larger values move pitch a lot more. A value of 100 will match exactly 127 semitones. This means is designed so that if you assign the KBD (MIDI note number) to pitch with a value of 100, then each note on the keyboard will play its correct frequency. A small value such as 10 will apply a small detune, such as for vibrato from an LFO. |
| OSC 1 WIDTH  | A value of 100 will match exactly 127 semitones. This means if you assign the KBD (MIDI note number) to pitch with a value of 100, then each note on the keyboard will play its correct frequency. A small value such as 10 will apply a small detune, such as for vibrato from an LFO.  |
| OSC 1 BLEND  | The pulse width and Sawtooth/Triangle shape amount of VCO1.  |
| OSC 1 MIX    | The Level of the OSC 1 outputs into the Mix. Note that a negative value at the Mix level amount destination mean that the OSC outputs will be inverted and mixed in at that level.   |
| OSC 2 TUNE   | See OSC 1 TUNE.  |
| OSC 2 WIDTH  | See OSC 1 WIDTH.   |
| OSC 2 MIX    | See OSC 1 MIX.   |
| OSC 3 TUNE   | See OSC 1 TUNE.  |
| OSC 3 POS    | OSC 3 Wavetable position.  |
| OSC 3 MIX    | See OSC 1 MIX.   |
| NOISE        | Level Noise/Fuzz source in the Mix. Note that a negative value at the Mix level amount destination mean that the OSC outputs will be inverted and mixed in at that level.  |
| LFO1/2 Rate  | The LFO 1 or LFO 2 Rate (according to the LFO1/2 Key). LFO 1 can modulate LFO 2 and vice versa. LFO 1 and 2 cannot modulate themselves.  |
| LFO1/2 Level | The LFO 1 or LFO 2 Level (according to the LFO1/2 Key). LFO 1 can modulate LFO 2 and vice versa. LFO 1 and 2 cannot modulate themselves.   |
| RESONANCE    | The VCF Resonance.   |
| CUTOFF       | The VCF Cutoff Frequency.  |
| DRIVE        | VCF overdrive level.   |
| EG1 ATTACK   | Envelope Generator 1 Attack Time.  |
| EG1 DECAY    | Envelope Generator 1 Decay Time.   |
| EG1 SUSTAIN  | Envelope Generator 1 Sustain Level.  |
| EG1 RELEASE  | Envelope Generator 1 Release Time.   |
| EG1 LVL      | Envelope Generator 1 Level. This scales the entire ADSR envelope of EG1, so maintains the shape while changing the amplitude of the envelope.  |
| MORPH        | Morph the patch between the saved A and B sounds. See the section on Morphing on page 15.  |
| EG2 ATTACK   | Envelope Generator 2 Attack Time.  |
| EG2 DECAY    | Envelope Generator 2 Decay Time.   |
| EG2 SUSTAIN  | Envelope Generator 2 Sustain Level.  |
| EG2 RELEASE  | Envelope Generator 2 Release Time.   |
| EG2 LVL      | Envelope Generator 2 Level. This scales the entire ADSR envelope of EG2, so maintains the shape while changing the amplitude of the envelope.  |
| SPIN         | Spin rate. See the section on Spin on page 24.   |
| PAN          | The Pan Position of the voice. The Pan response to the value is defined in the section Stereo Infinite Panning on page 23.   |

## Layer Setups & Multi-timbral Operation

Multi-timbral operation splits Nina into four independent synthesizers, on four layers.

Each synthesizer has a Preset loaded into it, a number of voices assigned to it, a start and end note of the keyboard and a MIDI channel that it responds to, and some other settings. When you change the current layer, the motorized controls all move to the settings for the Patch on that layer.

One examples of layer setups is to have the bottom half of the keyboard assigned to Layer 1 with a mono bass sound, and the top half of the keyboard to a polyphonic lead synthesizer sound, for live performance. Another example is to make a double-stack, where every note plays 2 different sounds together from 2 layers.

The LAYER menu is accessed by pressing the **LAYER Key**.



**All operation in Nina is intrinsically multi-layer.** Normal operation with a single timbre is just the simple case of Layer 1 having all 12 voices assigned to it, and layers 2, 3 and 4 turned off (0 voices assigned).

Layer 1 is the master layer. The Preset on Layer 1 determines the Effects, Arpeggiator and Sequencer configuration. There is only 1 Effects processor, Arpeggiator and Sequencer.

NOTE: Although every Preset stores its own settings for Effects, Arp and Sequencer, these settings are ignored on layers 2, 3 and 4. If you save a Preset on these layers, these settings are left unchanged in the Preset.

A **LAYER SETUP** is the complete set of all settings on all four layers. Layer Setups can be loaded and saved using combinations of the **LOAD + SAVE** keys while the **LAYER menu** is active (layer LED On). Layer Setup loading and saving is described in detail on page 33.

### LOAD A SAVED LAYER SETUP

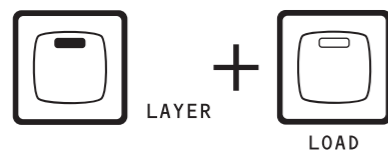

### SAVE A NEW LAYER SETUP

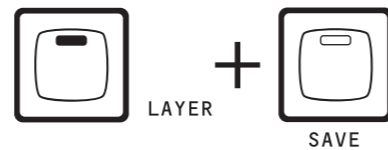

Also in the LAYER Menu are some parameters that are global level settings for the Patch on each layer, such as mono or polyphonic playing. Although these settings are accessed from the Layers Menu, they are actually loaded and saved with the Preset and not the Layer setup. The sections below are divided into Multi-timbral and Patch/Preset Settings.

NOTE: When you power on, Nina will reload the last used **Layer Setup**. Additionally, if you had loaded different Presets into any layers before you powered off, those Presets will be loaded after the Layer Setup is loaded. This will return you to the previous setup as quickly as possible when you power on, and remembers all the Presets you had loaded.

## Effects with Multi-Timbral

There is one effects processor in Nina. The Preset on Layer 1 determines the Effects configuration.

The Effects operate on Analog Outputs 1 and 2 (Left and Right, respectively). All layers that are routed to outputs 1 and 2 are mixed together and can have effects applied to them. All layers that are routed to Analog Outputs 3 and 4 have no effects applied to them, they are **clean outputs**.

For example, if you route Layers 1, 2 and 3 to outputs 1 and 2, the signals of layers 1, 2 and 3 are all added together and passed into the Effects processor. The effects are applied to this mix of layers 1, 2 and 3, and the Effected sound is then added to outputs 1 and 2. The Effects knob (level) determines how much of the Effected signal (wet) is added to the analog signal (dry).

## Arpeggiator with Multi-Timbral

Nina has one Arpeggiator, and it is configured from the Preset on Layer 1.

The arpeggiator receives notes from a keyboard, and sends them out in a repeating sequence. The MIDI channel assigned in Layer 1 is the channel used. All notes received on this MIDI channel will be arpeggiated and sent to the same channel.

If the channel is 0 (omni), then the notes received on any channel will be arpeggiated, and sent to the same channel that they came in on.

If Layers 2, 3 or 4 are configured with the same MIDI channel as layer 1, then the arpeggiated notes will play on layers 2, 3 or 4 also. If the Layer 1 MIDI channel is omni, then the arpeggiated notes will play on layer 1 and any other layer that has the same MIDI channel as the incoming notes.

## Multi-Timbral Configuration

Pressing the **LAYER key** will bring up the LAYER Menu. The first set of items in the list configure the multi-timbral operation:

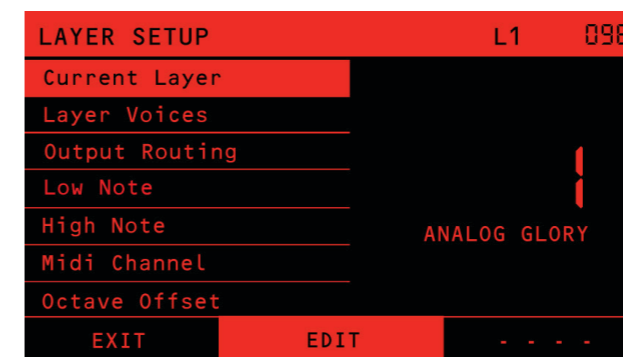

## Layers Reset

The **RESET soft-key** (bottom right) will reset the whole Layer Setup to single-timbre operation. This can be useful if the current layer configuration is complex and want to go to the basic working state.

**Pressing RESET will:**

- Assign 12 voices to Layer 1 and 0 voices to Layers 2, 3 and 4.
- Set the Output Routing to all outputs, 1-2-3-4.
- Set the Low note to 0 (lowest possible MIDI note).
- Set the High note to 127 (highest possible MIDI note).
- Set the MIDI Channel on Layer 1 to 0 (omni). Set the CV A Source to Analog Input 1 and the CV B Source to Analog Input 2.
- Set the Volume for Layer 1 to 100 (max).

Note that for a RESET, the settings on Layers 2, 3 and 4 are not changed, apart from the assignment of 0 voices.

A confirmation page with '**Reset layers back to one Layer default**' will appear. Press YES to confirm, or BACK if you don't want to reset.

## Layer Navigation

You can quickly change the active layer using the 1, 2, 3 and 4 Keys. You can also edit the 'Current Layer' value in the menu to change it.

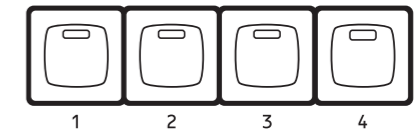

When you change layer, all the other items in the menu will show the settings for the layer, and the large number will show the layer number. Underneath the layer number will be the name of the Preset in the Layer, or '0 voices' if the layer is turned off.



The Knobs will all turn to the settings for the Preset on the active layer. Note that this will happen even if there are no voices assigned to the layer. If you increase the number of voices, then you will see the name of the Preset on that layer, and the controls will be ready for any notes played.

When you exit the layers menu, by either pressing the LAYER key again or the EXIT soft-key, the active layer will be shown in the title bar as **L1, L2, L3 or L4**.

## Layer Voices

This item sets the number of voices assigned to each layer, and you must manually set this. It is a foundation of the multi-timbral setup.

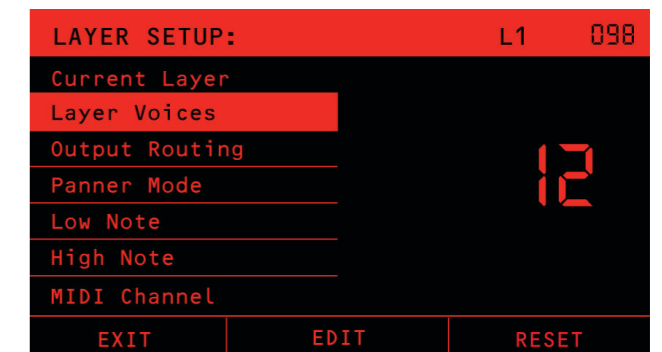

The total number of voices across the layers must be 12 or less. If you cannot increase the number of voices on a layer, then you may need to go to another layer and reduce the number of voices allocated to that layer. A layer assigned 0 voices is turned off.

TIP: The ONE LAYER default layer setup has 12 voices assigned to Layer 1. To enable more layers, you must first reduce this so you can allocate voices to other layers.

## Output Routing

This sets which of Nina's four analog outputs to send the layer to. Note that the voices are always stereo.

| Assignment | Routing   |
|------------|---|
| 1          | Route the Left signal from all the voices to Analog output 1.                 |
| 2          | Route the Right signal from all the voices to Analog output 2.                |
| 3          | Route the Left signal from all the voices to Analog output 3.                 |
| 4          | Route the Right signal from all the voices to Analog output 4.                |
| 1-2        | Route the stereo signal from all the voices to Analog outputs 1 & 2           |
| 3-4        | Route the stereo signal from all the voices to Analog outputs 3 & 4           |
| 1-2-3-4    | Route the stereo signal from all the voices to Analog outputs 1 & 2 and 3 & 4 |

## Low Note / High Note

These two settings are used to create keyboard splits. Notes in the range of Low Note to High Note (inclusive) will play on the layer, and all other notes ignored.

TIP: If you play a key on an attached keyboard while or after you press EDIT, then the note number will be set to that key.

## MIDI Channel

This setting chooses which MIDI channel the layer will respond to, from 1 to 16. The extra setting of 0 (omni) will make the layer respond to MIDI on all channels.

## Octave Offset

This setting will offset notes on the chosen layer by a selectable number of octaves.

## MPE

Nina supports MIDI Polyphonic Expression (MPE) to allow the performer to vary the pitch and timbre of notes individually while playing. Nina supports 3 dimensions of control, as defined by the MPE specification. These dimensions are (1) per-note Pitch Bend, (2) per-note Channel Aftertouch, and (3) per-note control using MIDI CC #74. An external MPE controller is required to use MPE on Nina.

MPE works across the normal 16 MIDI channels. You can choose how many MIDI channels you want to use for MPE, and the other channels will operate as standard normal MIDI.

MPE defines two zones, Upper and Lower. The Lower zone has a channel on channel 1, and the Upper Zone has the Master Channel on 16.



MPE on Nina works in conjunction with Multi-timbral operation. Each layer can either be an MPE instrument or a normal instrument. To turn on MPE mode, from the LAYER menu set MPE mode to "Master Ch 1" or "Master Ch 16". Then set the MPE Num Channels to the number of MIDI channels you want to assign to the MPE layer.

NOTE! Nina and the attached MPE controller must have the same settings of master channel and number of channels.

For typical operation, you should set the Layer Voices to the same as the MPE Num Channels. If you have a sound with Unison Voices greater than 1, then you should assign more voices, to allow Unison to play notes without voice stealing.

In MPE mode, the modulation matrix source labelled EXP is taken from MIDI CC #74, instead of the MIDI Expression Control.

NOTE: Nina's 'MPE System' Settings which relate to the way different MPE controllers work are set in the System->Global Settings menu. The MPE polyphonic pitch bench range, and the 'MPE UZ PB Range' sets the upper zone.

MPE CC polarity is selectable between Bipolar or Unipolar. This setting depends on the attached MPE controller. For typical operation, the Linnstrument, Erae Touch and Seaboard should be set to Bipolar and the Osrose to Unipolar.

## Volume

This setting sets the overall volume of the layer between 0 (silence) and 100 (full volume). Use this to adjust the mix of sounds that are going to the same analog outputs.

## CV A and CV B Source

Chooses which of the 4 analog inputs are used for the CVA and CVB Mod Matrix sources. For details on how to adjust the control voltage gains and offsets, see Global Settings on page 37.

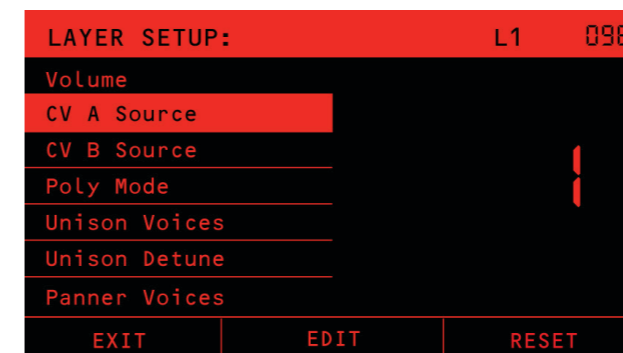

## Patch/Preset Global Settings

The following settings in the layer menu are actually part of the Preset on that layer, and are saved and loaded with the Preset, even though they are accessed from the LAYER key.

## Poly Mode

**Mono** mode is monophonic, only 1 voice is used. The EG1 and EG2 envelopes play the full ADSR with every new note played.

**Legato** sets Monophonic legato mode, where the envelope does not retrigger when you play legato style. If you release one note before pressing down the next, the envelope generator will restart from Attack. If you start playing a new note before you release the last one, then the envelope generator will not restart, it will just continue with the same envelope shape, and the oscillator will change pitch to the new note.

**Poly** mode is polyphonic. Notes are played up to the maximum number of voices.

NOTE: **Voice stealing:** If the maximum number of voices is allocated and a new note is played, then the oldest played note that is in its Release phase is taken. If no notes are in the release phase, then the oldest played note is taken.

## Unison Voices and Unison Detune

Unison Voices sets how many voices are played for each note. Because Nina is an analog instrument, each voice naturally has a slightly different character. Using unison to overlay multiple voices playing the same note gives a power and texture to the sound. Unison Detune adds to this difference in character by detuning the voices as they play together.

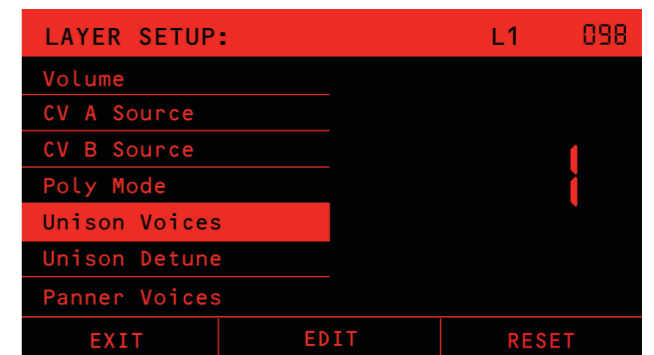

TIP: When you have a lot of voices playing in Unison, applying a small amount detune (eg 4) usually gives a nicer sound than having detune at 0.

## Panner Voices and Panner Mode

These two settings configure the Panner. For a detailed description of how the Panner operates, see The Panner on page 25.

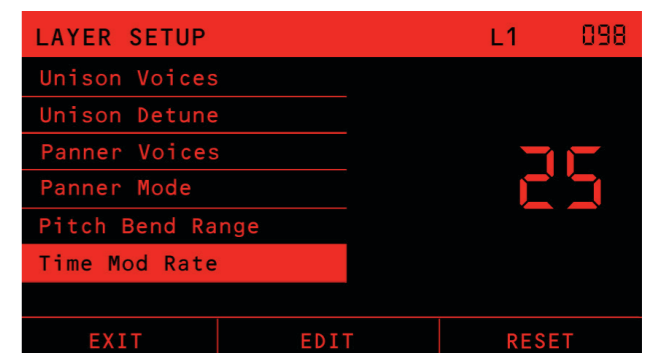

## Time Mod Rate

This sets the speed of the Time modulation source. See the section on Modulation Sources on page 25 for details.

# Layer Setups & Multi-timbral Operation: Block Diagram

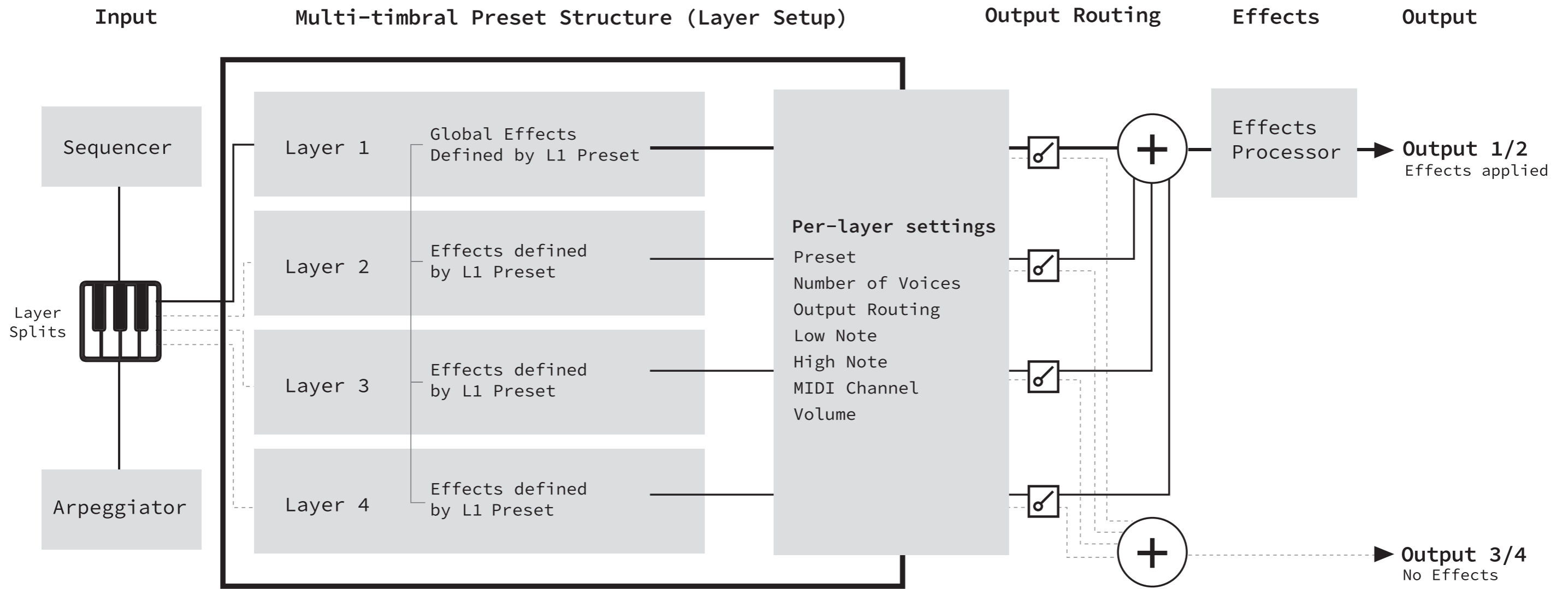



## Loading and Saving Layer Setups

Up to 127 LAYER Setups can be stored on Nina. When the Layer menu is active and the LAYER Key LED is on, press LOAD or SAVE to load or save layer setups.

### Load Layer Setups

If you press LOAD, the display shows a list of all saved layer setups:

| LAYERS             | L1     | 098  |
|--------------------|--------|------|
| 01 SINGLE LAYER    |        |      |
| 02 2 PART          |        |      |
| 03 4 PART          |        |      |
| 04 4 PART OVERLAP  |        |      |
| 05 3 PART OVERLAP  |        |      |
| 06 STANDARD STEREO |        |      |
| 07 MULTI PART      |        |      |
| EXIT               | RENAME | LOAD |

NOTE that there is a default layer setup called "ONE LAYER". This setup is for single timbre operation, with 12 voices assigned to layer 1 and layers 2, 3 and 4 all turned off (0 voices assigned).

### Save Layer Setups

To save the current/new LAYER Setup, choose a position on the list where you want to save and press the **SAVE soft-key**. The display will go to the rename page, which will allow you to set the name that you wish to save. The renaming works in the same way as for saving Presets, see Saving Presets on page 15. Press the ENTER soft-key to save the layer setup or the BACK soft-key if you change your mind.

| LAYERS             | L1    | 098  |
|--------------------|-------|------|
| 01 SINGLE LAYER    |       |      |
| 02 2 PART          |       |      |
| 03 4 PART          |       |      |
| 04 4 PART OVERLAP  |       |      |
| 05 MY NEW SETUP    |       |      |
| 06 STANDARD STEREO |       |      |
| 07 MULTI PART      |       |      |
| EXIT               | - - - | SAVE |

## Arpeggiator

Nina has a simple Arpeggiator. If you play multiple notes, the Arpeggiator will play those notes in an repeating sequence, according to its settings and the rate control TEMPO Knob.

The settings for the Arpeggiator are saved with the Presets. When you load or save a Preset, the Arpeggiator settings will be loaded or saved with it.

NOTE that for Multi-Timbral setups, the Arpeggiator is tied to the Preset on Layer 1 only. See the section on Layer Setups & Multi-timbral on page 31.

### Basic Operation

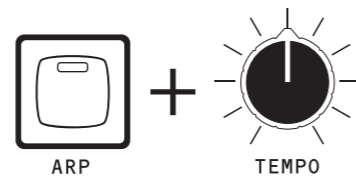

The **ARP Key** is used to turn the Arpeggiator on and off, and to access the Arpeggiator settings.

A **short press** of the Arp Key will turn the Arpeggiator ON or OFF, and display the settings. A **long press** (more than ½ second) of the ARP Key will bring up the Arpeggiator settings without changing whether it is on or off.

| ARP:       | L1   | 098   |
|------------|------|-------|
| Enable     |      |       |
| Dir Mode   |      |       |
| Hold       |      |       |
| Note Value |      |       |
| EXIT       | EDIT | - - - |

The arpeggiator receives notes from a keyboard, and plays them out in a repeating sequence. The MIDI channel assigned in Layer 1 in the LAYERS Menu is the channel used. All notes received on this MIDI channel will be Arpeggiated and sent to the same channel. If the channel is O (omni), then the notes received on any channel will be arpeggiated, and sent to the same channel that they came in on. For details of the MIDI channel assignments in a Multi-Timbral setup see the section Arpeggiator with Multi-Timbral on page 30.

The Arpeggiator settings are described below:

### Dir Mode

Sets the direction of notes played out. For example, if the Temp is 60 BPM, and the setting is "1/4", the Arpeggiator will play one note per second. The "T" settings have triplet timing.

| Assignment | Routing  |
|------------|--|
| Up         | Notes are played from the lowest to the highest, then restarting from the lowest.  |
| Down       | Notes are played from the highest to the lowest, then restarting from the highest. |
| Up-down    | Notes are played from the lowest to the highest, then back down to the lowest.     |
| Random     | Notes are played in a random order. They are shuffled each time they repeat.       |
| Assigned   | Notes are played in the order they were played on the keyboard.                    |

### Hold

With Hold on, the arpeggiator will continue to play after you release the notes, until you turn the arpeggiator off.

With hold off, the arpeggiator will play out while you hold notes down, and will stop when you release the notes.

### Note Value

Multiplies the TEMPO BPM to play the Arpeggiator. The meaning of Beats per Minute follows the MIDI convention that a Beat is a quarter-note.

For example, if the Tempo is 60 BPM, and the setting is 1/4, the Arpeggiator will play one note per second. The T settings have triplet timing.

| Setting | Multiplier                   |
|---------|------------------------------|
| 1/4     | 1 note per Beat              |
| 1/8     | 2 notes per Beat             |
| 1/16    | 4 notes per Beat             |
| 1/32    | 8 notes per Beat             |
| 1/4T    | 1.5 notes per Beat (Triplet) |
| 1/8T    | 3 notes per Beat (Triplet)   |
| 1/16T   | 6 notes per Beat (Triplet)   |
| 1/32T   | 12 notes per Beat (Triplet)  |

### External Sync

You can lock the arpeggiator and sequencer to an external MIDI clock source, such as a DAW, to keep it in time with other instruments. External sync operation is set in the System Menu, see page 39.

## Sequencer

Nina has a 16 step sequencer. The sequencer notes and settings are stored with each Preset. Each step is polyphonic, so can record chords or single notes.

The sequencer settings are accessed by pressing the **SEQ Key**. The **REC Key** is used to record a new sequence and the **RUN Key** to run it. The Sequencer is triggered by playing a note, and the sequence is transposed to start playing from the note you play. The sequencer can free-run (when the Hold setting is On) or run only when you hold down a note (when the Hold setting is Off).

The sequencer is a step sequencer so it records the notes but not the velocity, duration, or control changes.

## Recording a Sequence

To record a new sequence, press the **REC Key**. Play one or more notes at the same time. When you release all notes, this will record one step and move to the next.



**Keys 1-16** LED will show the current step, stepping forward as you play. Notes can also be played using the internal KBD function.

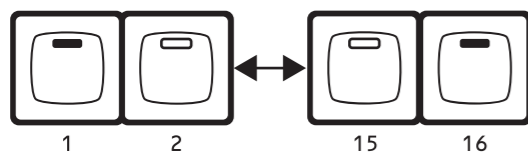

To finish the sequence, press REC again.

To insert a rest (silence for 1 step), press the currently illuminated Key from 1-16. For example, when you press REC, Key 1 will illuminate to show that is the current step, if you press 1, then a rest will be placed at step one, and it will move to step 2.

To insert a tie (hold a note for a number of steps), press the step one or more ahead of the currently illuminated step. For example, when you press REC, Key 1 will illuminate, if you press 2, then Keys 1 and 2 will illuminate, and the next note you play will play at step 1 and tie for step 2.

## Playing a Sequence

Press the **RUN Key** to run the sequencer. If the **Hold** setting is ON, it will free-run. If it is OFF then it will play once if you press a key, or continue to cycle through the sequence when you hold down a note. The sequence will be transposed to play from the note you play, at any step in the sequence.

## KBD

The **KBD key** activates the internal keyboard. This makes the 1-16 Keys into a simple 16 note keyboard. The keys are in semitone steps, and the sharps and flats are shown where the LEDs are ON.

When KBD is pressed and the keyboard is turned on, the **KEYBOARD** menu is shown. This has 2 options. The **First Note** option, sets the bottom note of the 16 keys. The default is middle C, which is note number 60 or C4 in MIDI note numbers.

The **KBD MIDI Channel** option sets the MIDI operation. The internal keyboard works by sending notes to a MIDI channel internally in the synthesizer. Which sounds are played by these notes depends on the multi-timbral MIDI setup as defined in the **LAYER** menu (see page 32).

## All Notes Off

In the situation where a hung note persists or another anomaly or external device causes unwanted audio output, the KBD switch will turn all notes off when held down for more than two seconds.

## Effects

Nina has three digital effects processors. The three effects can be placed in any order and each effect has its own wet/dry mix level. The main channel 1 and 2 mix is sampled with a 96kHz, 24 bit ADC, processed in stereo by the effects and then added back to the outputs. The Effects menu is displayed when the **EFFECT Knob** is used (unless **LOAD**, **SAVE**, **LAYER** or **MOD** is already active).

There are 3 'slots' which are used to set the order of effects processing. The main left and right sound output is feed into slot 1 then slot 2 and finally slot 3. Effects placed in the same slot are processed in parallel and then mixed together. This is shown in the diagram below:

In the fig. 1, the analog sound is fed into chorus, delay and reverb all in slot 1,

The effects configuration is saved in the Presets, not in the Layers. In Multi-Timbral Layer the effects are defined by the Preset in Layer 1.

If you switch to layers 2, 3 or 4, you will always be using the effects settings on Layer 1. If you want to save the effects configuration, you will need to save the Preset on Layer 1.

Fig. 1

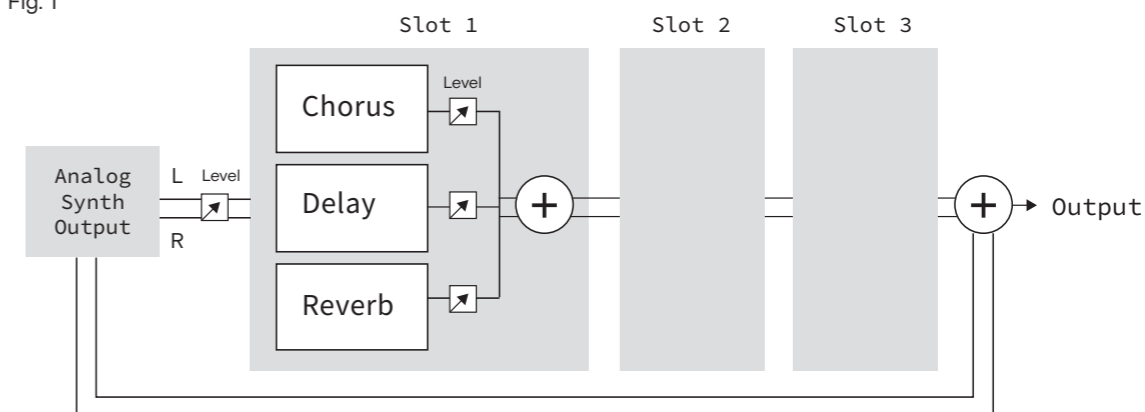

Fig. 2

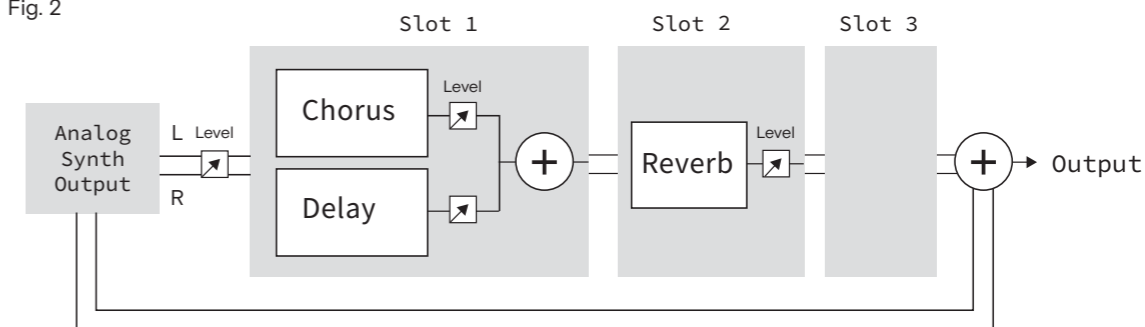
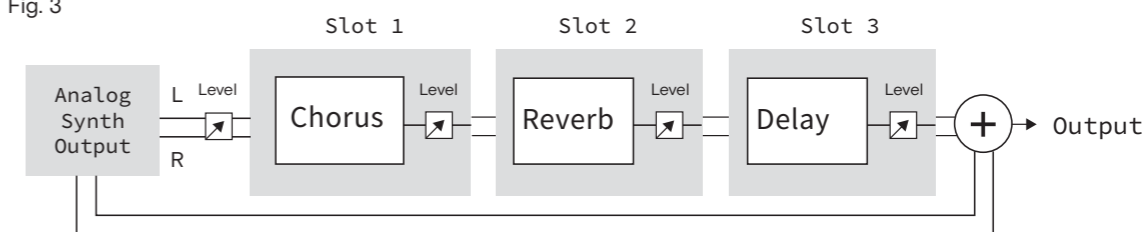
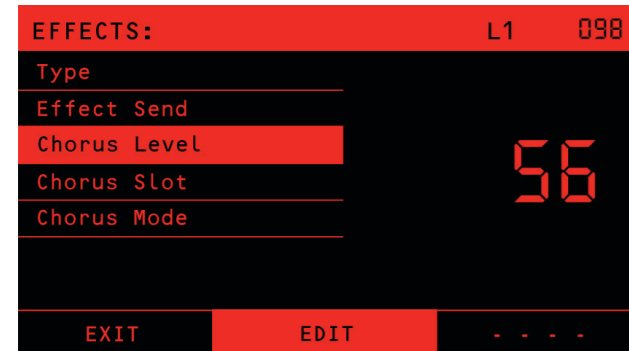

Fig. 3



## Chorus

The Chorus effect is a simple classic synthesizer chorus. The Chorus Mode has simple selection of type. Type I adds a gentle shimmer to the sound, type II has a deeper, wider effect and both can be turned on together. Note that the Chorus effect is much more pronounced when the voices have stereo spread. For example, if you are playing just single note lead, then the combination of a number of Unison voices and Stereo spread using the Panner will make the Chorus do a lot more to the sound.



Effects Menu, showing Effects level, slot, type and mode.



## Delay

The delay is a digital delay with adjustable time and feedback level with a low-pass filter. It can be synchronized to the Arpeggiator / Sequencer. The settings are as follows:

| Setting                | Description   |
|------------------------|---|
| <b>Delay Time</b>      | Sets the delay from 60ms at minimum (0) to 1.8 seconds at 100. Used when Sync is Off.   |
| <b>Delay Time Sync</b> | Sets the delay as a multiple of the Sequencer/Arpeggiator clock. Used when Sync is On. The multiple settings are the same choices as for the LFO Sync. See page 26. |
| <b>Sync</b>            | Choose which of the two above Delay times are used.   |
| <b>Delay Feedback</b>  | Sets the level of the feedback. 0 is no feedback, so there will just be one repeat. 100 is feedback at 100% level.  |
| <b>Delay Tone</b>      | Sets the frequency of the low pass filter on the feedback loop. The filter is 6dB per octave, so each repeat will sound progressively darker.                       |

## Reverb

The Reverb effect has a number of Presets, and then a number of parameters that can be adjusted to change the effect. Note that the Presets configure the effect into distinct modes of operation and are not just a way of recalling the other settings. Room reverb emulates a reverberant room, Hall 1 and 2 a small and large hall, and plate 1 and 2 emulate a small and large metal plate reverb.

| Setting                 | Description   |
|-------------------------|---|
| <b>Reverb Preset</b>    | Choose between a <b>room, plate 1, plate 2, hall 1</b> and <b>hall 2</b> effect.                            |
| <b>Reverb Decay</b>     | Sets how fast the reverb decays to silence. Low values are fast and high slower.                            |
| <b>Reverb Predelay</b>  | Sets the initial delay before the sound starts to reverb.   |
| <b>Reverb Early Mix</b> | Sets the level of the early reflections, which gives the impression of how large the room or chamber is.    |
| <b>Reverb Tone</b>      | Sets how bright or dark the reverb sounds, by adjusting a low pass filter.                                  |
| <b>Reverb Shimmer</b>   | Shimmer is created by mixing in the reverb pitch shifted up one octave. Shimmer sets the level of this mix. |

## System Functions

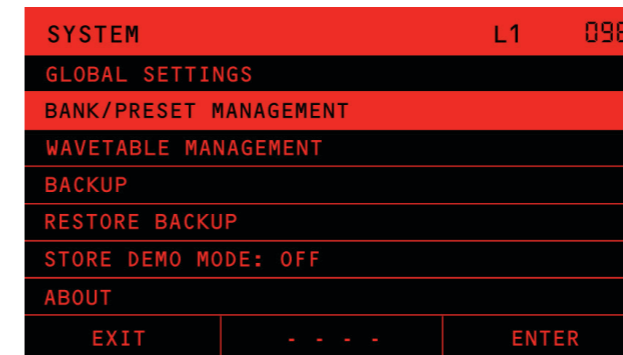

## Global Settings

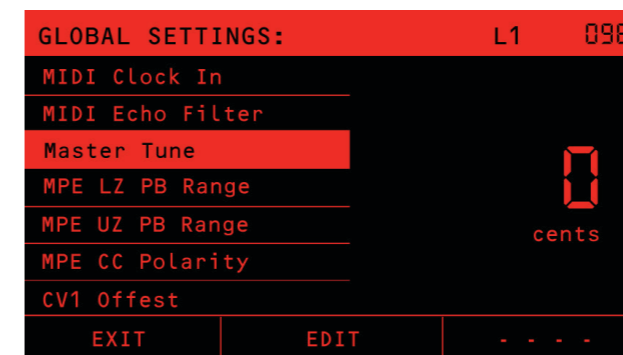

## Midi Clock In

If set to On, the sequencer and arpeggiator will use MIDI clock coming in. If set to Off, the internal clock, as set by the TEMPO Knob will be used.

## Midi Echo Filter

The MIDI Echo filter fixes a problem with DAWs and external devices which send back all MIDI Configuration Controller (CC) messages when they receive them. If this happens, the knobs will send MIDI CC messages as you turn them, but then be told by the external device to put them back to where they were, creating a feedback loop fighting for position. The settings are:

| Setting            | Description  |
|--------------------|--|
| <b>No filter</b>   | MIDI Echo Filter is Off. Use this only if external devices or DAWs do not echo.                    |
| <b>Echo Filter</b> | MIDI CCs that are detected as an echo are removed. Other received CCs will be followed.            |
| <b>Filter All</b>  | All incoming MIDI CCs are ignored. Use this if you do not want any external control or automation. |

## Master Tuning

Master tuning can be used to tune the entire instrument up or down from -200 to 200 cents.

## CV Offset Gain and Mode

These settings are to precisely calibrate or tune the response to an external Control Voltage input. The CV's follow the 1 Volt-per-octave convention. The CV Modes are:

| Setting       | Description                               |
|---------------|---|
| <b>-10:10</b> | Range is -10V to +10V. 0V is nominally C4 |
| <b>0:10</b>   | Range is 0V to +10V. 5V is nominally C4   |
| <b>-5:5</b>   | Range is -10V to +10V. 0V is nominally C4 |
| <b>0:5</b>    | Range is -0V to +5V. 2.5V is nominally C4 |

## Backup

The Backup & Restore menu items will be available when a FAT32 formatted USB Flash drive is plugged into one of the USB-A ports on the back.

Backup will save the complete set of user data to two zip files on the drive. Press the ENTER soft-key on the BACKUP list item to perform the backup. The two files will be called "patches\_backup\_NNNN.zip" and "calibration\_SSSS.zip", where NNNN and SSSS are 2 automatically generated numbers.

The patches\_backup\_NNNN.zip file contains all of the Layer setups and Presets that are on the unit. It will not include the default preset called BASIC or BACKUP, only presets that either in the supplied factory set and all user created Presets. The number NNNN is an automatically increasing number that goes up by one each time a backup is done.

The calibration\_SSSS.zip stores all of the factory analog calibration settings. SSSS is the unique internal serial number of the NINA unit. You should normally never need to use this file, and is there for customer support and servicing use only.

## Restore

The RESTORE Menu item will be available if a USB flash drive is inserted and there is a file called "patches\_backup.zip" on it. Note that this file name does not have a number suffix. If you wish to restore from a previously made backup, first rename the file from "patches\_backup\_NNNN.zip" to "patches\_backup.zip".

When you start the restore operation, Nina will first do a backup and write it to the flash drive. This is for safety, because the restore is a complete overwrite. The restore



operation will read all patches and layer setups from the backup and overwrite those currently on Nina, in the same Preset locations as they are in the backup.

## Bank/Preset Management

Whole banks of Presets can be exported and imported from a USB flash drive. This can be used to share patches, copy and there are other functions to help organize the Presets on Nina.

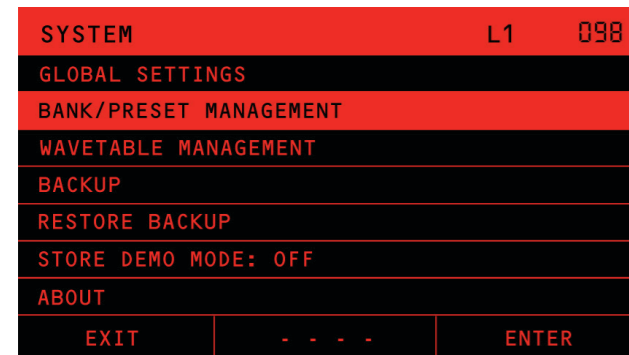

From the home screen, press the SYSTEM soft-key and then choose BANK/PRESET MANAGEMENT to access these functions.

## Import Bank

Banks are stored as zip files. The name of the bank is in the file (eg NINA\_BANK\_BASSES.zip for a bank called BASSES) and the patches are **.json files** inside it.

To import, insert a USB flash drive containing the zip file you want, and choose **Import Bank** from the list shown via SYSTEM -> BANK/PRESET MANAGEMENT.

NOTE: If you are preparing your own Banks on Mac or PC, do not include any folder hierarchy in the zip file. The zip file should contain .json files and no folders.

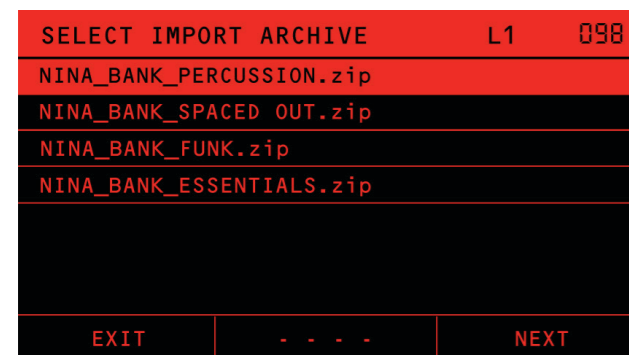

Choose the zip file you want and press the **NEXT soft-key**. You will then be asked where to store the bank, the screen will show the list of all banks currently in NINA.

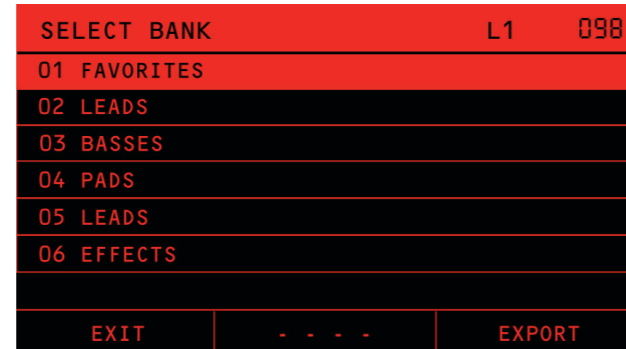

Choose the BANK where you want to store the imported Presets and press the **NEXT soft-key** again. You will then be asked if you want to Merge or Overwrite the presets in the bank.



If you choose **OVERWRITE**, then Nina will write all of the Presets in the zip file to the bank in their number order. The Presets in the Bank will be overwritten and the Bank will be renamed to the name of the zip file. Note that if there are more Presets in the destination bank than in the zip file, the import will not delete the extra Presets in the bank. For example if there are 20 Presets in the destination bank and only 5 in the zip file, Nina will overwrite the first 5 and the other 15 will still be there after import.

If you choose **MERGE** then Nina will read all the Presets from the zip file, and add all new Presets into the destination bank, without affecting the Presets already in that bank. If there is a Preset in the Bank already with the same name, then it will skip (not import) the Preset. All new Presets will be written to the Bank, to fill all the empty locations. An empty location in the Bank is one that has a Preset called BLANK or BASIC, depending on the firmware version.

Example: A friend gives you a Bank of Presets with some bass sounds. When you import, you choose the destination bank called BASSES, and choose **MERGE**. This will add the new sounds to your unit, and keep everything you had there.

NOTE: For a **MERGE** import, Nina will first check if there is enough free space in the destination Bank for the new patches. If there is not, it will tell you the import cannot be done. In this case, choose a different bank, create a new one, or use **OVERWRITE**.

After import is complete, you will be asked if you want to Eject the USB flash drive. Choose **EJECT** and remove the drive, or choose **BACK** if you want to do something else with the drive eg import another bank of Presets.

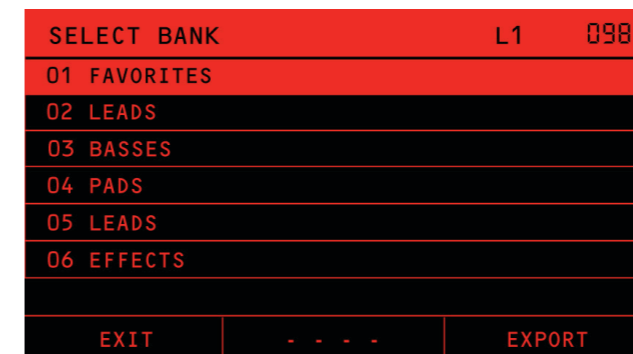

## Export Bank

Choose **Export Bank** to write a bank of Presets to a USB flash drive. After you choose Export Bank, you will be asked to choose which bank. A zip file will be created called NINA\_BANK\_NAME.zip, where NAME will be the name of the bank exported.

TIP: You can make a copy of an entire Bank of Presets on Nina by using Export Bank and then Import Bank.

If you want to make a selection of Presets to share, create a new bank, load up each Preset and save it to your new bank. Rename your new bank and export it.

After the export, the display will show **'Bank export complete'** and you will be asked if you want to **EJECT** the USB drive. Choose **EJECT** and remove drive, or choose **BACK** if you want to do something else with the drive eg export another bank of Presets.

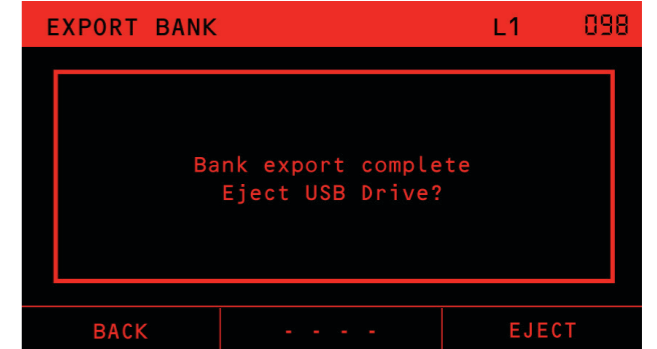

## Add bank

The **Add Bank** function will create a new Bank of 127 Presets. The Bank's name will be BANK. The Presets will all be empty. As usual, empty Presets will show the BASIC Preset. You can rename the BANK after it is created, from the **LOAD** or **SAVE** menus.



## Clear Bank

The **Clear Bank** function will delete all Presets from a Bank. Choose the Bank you want and confirm the delete. Note that there is no Undo, so it is a very good idea to do Export the BANK or to a complete Backup to the USB flash drive first.

After a bank is cleared, as usual it will show 127 entries with the BASIC Preset. The BASIC Preset is always shown in every location in a Bank where there is no factory or user-saved Preset.

## Wavetable Management

The **Wavetable Management** function allows import and export of wavetables to a zip file on a USB flash drive. For details on the wavetable file format, see page 44.

### Import Wavetables

Choose Import Wavetables from the list. Nina will look for a file called nina\_wavetables.zip and read all the wavetables on the drive and copy them into its internal storage. After import, you can find the new wavetables by pressing the SHAPE Key. Wavetables are listed in alphabetical order. A maximum of 127 wavetables can be loaded.

### Export Wavetables

Choose Export Wavetables from the list. Nina will create a file called nina\_wavetables.zip, with all of the imported wavetables in its storage. The factory built-in wavetables will not be exported.

### Delete Unused Wavetables

This function allows clean up of imported wavetables. It scans all the Presets to determine which wavetables are used, and which are not. All wavetables that are not used are deleted. The factory loaded wavetables are not deleted by this operation.

### About

The ABOUT item on the SYSTEM menu will show you the current System firmware revision number in the first line, and a number of internal numbers and status.

| ABOUT                | L1 | 098 |
|----------------------|----|-----|
| SYSTEM: 1.1.0        |    |     |
| OS: 5.4.90-v1        |    |     |
| UI: 1.1.0-95a        |    |     |
| GUI: 1.1.0-96a       |    |     |
| VST HOST: 0.12.0-36c |    |     |
| VST: 1.1.0-101       |    |     |
| HOSTNAME: nina-pi    |    |     |
| EXIT                 |    |     |

## Firmware Upgrades

To perform a firmware upgrade, first download the NINA firmware and copy onto a FAT32 formatted USB flash drive. The file is an **.swu (software upgrade) file**.

It will take around 5 minutes for the whole process, so make sure you have time and reliable power when you do it.

After Reboot, Nina may run a Calibration, depending on the firmware version and state of the unit. This process can take up to 10 minutes.

Power off Nina, insert the flash drive into either one of the USB-A ports, and power on Nina. Nina will boot up to the Knob calibration stage, and then read the ".swu" file. At this point it will display that it is doing the firmware upgrade, and the version number:

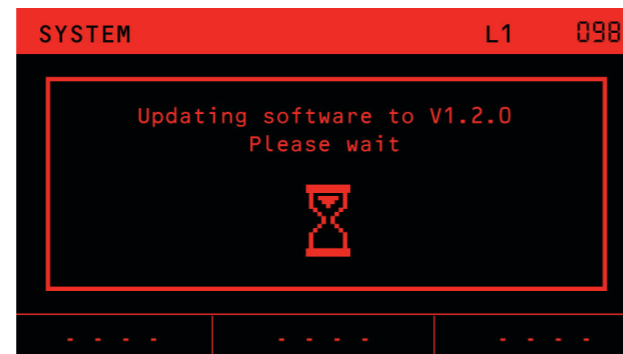

The hourglass symbol will spin to show you the unit is running.

**WARNING: Do not Power off while the Nina Update is running**

After the upgrade is finished, you will be asked to reboot. Press OK. The unit will then reboot with the new firmware loaded. You can check the version in the ABOUT item in the SYSTEM menu.

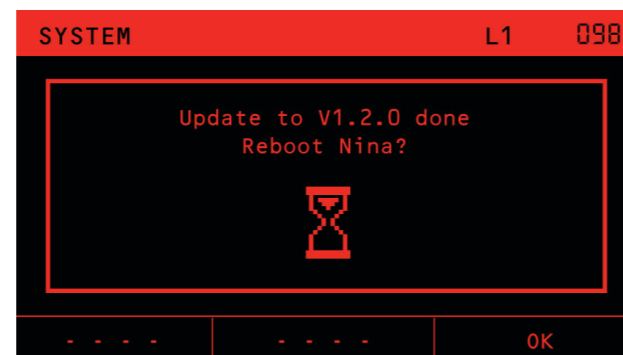

### USB Flash Drive Removal

USB flash or thumb drives may be removed safely if you have finished all operations with them. Do not remove them while Nina is actively writing to them e.g. EXPORT BANK. At times you will be asked if you want to EJECT them. This is mainly for convenience, and to make it clear that the device is finished being used and ejecting is safe. If you choose EJECT, the device will not be seen by Nina until you remove and reinsert it.

## Appendix A: MIDI Control

The CC messages 64 and above are not shown. Nina uses CC and not RPN/NRPN message for external control and automation.

The USB-C connector on the rear port exposes a class compliant USB MIDI device to a connected host computer. The DIN MIDI IN supports the same functions.

| Channel | Param.                                 | Channel | Param.                                     |
|---------|--|---------|--|
| 0       | Bank Select (MSB)                      | 32      | Bank Select (LSB) 00-31 selects Banks 1-32 |
| 1       | Mod Wheel                              | 33      | EG1 Attack                                 |
| 2       | Mod Matrix MIDI Source                 | 34      | EG1 Decay                                  |
| 3       | <Unused >                              | 35      | EG1 Sustain                                |
| 4       | <Unused >                              | 36      | EG1 Release                                |
| 5       | Glide Rate                             | 37      | EG2 Attack                                 |
| 6       | (Reserved) Data Entry MSB for RPN/NRPN | 38      | (Reserved) Data Entry LSB for RPN/NRPN     |
| 7       | Patch Volume                           | 39      | EG2 Decay                                  |
| 8       | <Unused >                              | 40      | EG2 Sustain                                |
| 9       | <Unused >                              | 41      | EG2 Release                                |
| 10      | Pan                                    | 42      | Spin                                       |
| 11      | Expression Source                      | 43      | Morph                                      |
| 12      | Effect Level                           | 44      | Morph                                      |
| 13      | <Unused >                              | 45      | <Unused >                                  |
| 14      | Osc 1 tune                             | 46      | <Unused >                                  |
| 15      | Osc 2 tune                             | 47      | <Unused >                                  |
| 16      | Osc 3 tune                             | 48      | <Unused >                                  |
| 17      | Osc 1 width                            | 49      | <Unused >                                  |
| 18      | Osc 2 width                            | 50      | <Unused >                                  |
| 19      | Osc 3 width                            | 51      | <Unused >                                  |
| 20      | Osc 1 Blend                            | 52      | <Unused >                                  |
| 21      | Osc 2 Blend                            | 53      | <Unused >                                  |
| 22      | Osc 3 Level                            | 54      | <Unused >                                  |
| 23      | LFO 1 Rate                             | 55      | <Unused >                                  |
| 24      | Osc 1 Level                            | 56      | <Unused >                                  |
| 25      | Osc 2 Level                            | 57      | <Unused >                                  |
| 26      | Noise Level                            | 58      | <Unused >                                  |
| 27      | LFO 1 Level                            | 59      | <Unused >                                  |
| 28      | Resonance                              | 60      | <Unused >                                  |
| 29      | Cutoff                                 | 61      | <Unused >                                  |
| 30      | Drive                                  | 62      | <Unused >                                  |
| 31      | Env Amount                             | 63      | <Unused >                                  |

## Appendix B: Wavetables

The wavetables are stored in WAV file format. Each waveform is encoded in 2048 samples, and there can be from 1 to 256 waveforms.

The bit depth of the WAV file may be 16 or 24 bit.

The waveform's 2048 samples is usually just one cycle of the waveform. Nina assumes this, and the waveform is automatically resampled to the pitch of the notes played.

NOTE: The maximum number of wavetables you can load at one time is 127. This includes factory loaded wavetables. When adding new wavetables, ensure that your new set + factory wavetables combined does not exceed 127. To make space for new wavetables use the Wavetable Management feature (page 42) to scan and remove unused wavetables

## Appendix C: Technical Specifications

### Polyphony & Multi-Timbres

12 Voices Polyphonic  
4 part multi-timbral.  
Independent voice routing to main (1 & 2) and/or Aux (3 & 4) outputs

### Voices

2 Analog VCOs with variable triangle/sawtooth shape. Pulse and Triangle/Sawtooth outputs.  
Hard Sync and Sub Oscillator Operation for Analog VCOs  
1 Analog XOR pulse ring-modulator  
1 Digital Wavetable. Wavetables from 1-256 waveforms. User loadable.  
Fine & Course tune control. 8 octave range.  
1 Digital Noise source  
External Audio feed In.  
Main output audio feedback into voices.  
2 ADSR Envelopes with traditional slopes and fast attack  
Low Pass transistor ladder filter 24dB/oct with Resonance.  
VCF Overdrive circuit  
2 digital LFOs. 6 waveform shapes.  
Stereo VCAs, four-quadrant (through zero) VCA with Stereo Infinite Panning

### Modulation matrix

16 sources to 27 destinations. No slot count limitation.  
Modulation amounts bipolar (through zero).  
Morph continuous between 2 patches.  
Morphable modulation settings.

### Digital Effects

1 Digital Effects unit on main mix output to Line Outputs 1 and 2  
Stereo Reverb, Delay or Chorus  
96kHz, 24 bit processing.

### Arpeggiator

Directions: up, down, up-down, random, assigned  
Hold function.  
Timing divisions 1/4, 1/8, 1/16, 1/4T, 1/8T, 1/16T

### Memory

Up to 16,129 Presets arranged in 127 Banks of 127 Presets.  
User import and export to USB media.  
127 Multi-timbral layer setups.  
User import and export to USB media.  
128 Wavetables.  
Import and Export in WAV format to USB media.

### CV Inputs

4 Analog inputs may be line or CV

### Electrical

Line Level Inputs: 1/4" TRS. 56k Ohm. Unbalanced 13dBu. Balanced 19dBu  
CV Inputs: 1/4" TS Unbalanced: 0 to 10V; -5 to 5V; 0 to 5V; -10V to 10V  
Mic Input: XLR Balanced. 2400 Ohm. +30 to +50 dB gain.  
Line Out 1 & 2: 1/4" TRS pseudo-balanced\*. 120 Ohm. 8.2dBu (nom). Attenuated with Main potentiometer, digital Effects summed.  
Line Out 3 & 4: 1/4" TRS pseudo-balanced\*. 120 Ohm. 8.2dBu (nom). No effects or attenuation.  
2 USB-A 3.0/2.0 host connection. 5V/500mA  
1 USB-C 2.0 device connection. MIDI USB class-compliant device.  
1 DIN MIDI In + MIDI Out + MIDI Through  
1 DC IN 12V. 12V, 8A AC/DC adapter supplied  
Power: 30W (nominal), 70W (peak).  
Operating Ambient Temperature: 0-40 C°

### Mechanical

Weight: 5.5kg (12lb)  
Dimensions: 446mm x 230mm x 71mm (17.6" x 9.1" x 2.8").  
19" rack mount ears included  
854px x 480px 2.95" LED backlit LCD

### Arpeggiator

Directions: up, down, up-down, random, assigned  
Hold function.  
Timing divisions 1/4, 1/8, 1/16, 1/4T, 1/8T, 1/16T

---

## Appendix D: Troubleshooting & Support

Please visit [melbourneinstruments.com/support](https://melbourneinstruments.com/support) for more information.

Email: [support@melbourneinstruments.com](mailto:support@melbourneinstruments.com)

---

## Warranty

Melbourne Instruments Pty. Ltd. warrants that:

- (a) The main product, not including or any external accessories, will be free from defects in materials and workmanship for a period of 2 years from the date of purchase.
- (b) Please contact us by email at [rma@melbourneinstruments.com](mailto:rma@melbourneinstruments.com) to notify us of any material or processing faults or defects to the Goods during the Warranty Period. Our authorised Personnel will review your claim and may request any further details of the fault or defect including photos, proof of purchase, the serial number of the Goods (if any) and any other material required to substantiate the claim. We reserve the right to reject a warranty claim if you fail to provide any of the information requested by us that is reasonably necessary for us to substantiate your claim.
- (c) The warranty only extends to the original (first) owner and is not transferable. If the goods have been used for hire, the warranty does not apply and is voided.
- (d) You must not return the goods to us unless requested to do so by our authorised personnel. We will pay the associated shipping costs and insurance provided the warranty claim is made within 30 days of delivery of the Goods (and we have approved the return of the goods back to us). You must pay all relevant shipping costs and insurance when shipping the goods to us in respect of any warranty claim received after 30 days from delivery. All risk in respect of the goods will remain with you.
- (e) You must remove all accessories and components attached to the goods prior to shipping the goods back to us. Under no circumstances will Melbourne Instruments Pty. Ltd. be liable for any loss or damage to any accessories or components attached to the goods.
- (f) Any repair work carried out on the Goods by any person other than our Personnel will void the warranty.
- (g) We incur no liability for, and no warranty claim may be made by you for, any damage caused by normal wear and tear, accidents, accidental damage, unauthorised modifications, negligence, or improper handling of the Goods or arising as a result of the occurrence of any of the other events set out in clause 16.
- (h) Full details of our warranty policy are set out in our User Manual and which form part of these Terms. You can access the User Manual at the [melbourneinstruments.com/support](https://melbourneinstruments.com/support). Please follow the instructions in our User Manual for making a warranty claim.
- (i) Any goods accepted by us as being defective or faulty in accordance with the warranty policy during the Warranty Period will be replaced or repaired by us (at our option).
- (j) The Warranty Period is not extended in the case of a repair or replacement.
- (k) We reserve the right to change our warranty policy (including the duration of the warranty) from time to time. Notice of any such changes to these policies or schemes will be provided by Melbourne Instruments by posting a notification on our Site or providing an updated User Manual, or as otherwise deemed appropriate by Melbourne Instruments.





**[melbourneinstruments.com](https://melbourneinstruments.com)**

User & Technical Support: [support@melbourneinstruments.com](mailto:support@melbourneinstruments.com)